



**oechsle display systems**  
*reliable and innovative*



## PRIMA SHELF MANAGEMENT SYSTEMS



SHELF DIVIDERS AND PUSHERS



VARIOTRAY



PRIMA 2.0



T-PROFILE RAILS



GRAVITY FEED



SPECIAL APPLICATIONS

# SHELF MANAGEMENT SYSTEMS

## WELCOME



Dear business friends,

On the following pages of this **special catalogue** we are glad to present you our extensive and complete product range with many different solutions for a perfect shelf management.

With our quality Shelf Dividers and Product Pushers you will optimize your product presentation:

Using this visually impressive and sales supporting shelf organization, means reducing costs for shelf care, while increasing your efficiency.

The complete Oechsle range with a variety of solutions for product and price marking, shelf and counter marking, general sales promotion, campaign advertising and much more you will find in our **complete catalogue "Display Collection"**.

Coming to screen and digital printing, acrylic displays, customized display manufacturing and all aspects of the visual shop decoration, our partner **werba print and display** is well-known as a leading specialist with long-term experience. The **"Insights"** brochure is presenting you a fine selection of the various possibilities.

We would be very glad to receive your individual and specific product requirements. My motivated team is taking care of your concerns – fast and competent.

**With Oechsle on your side you are in best hands – we are taking care of all your needs!**

With the best wishes for a successful and pleasant cooperation.

Yours  
Margit Oechsle  
Managing Director





1. NEWS	4-5
---------	-----

## 2. SHELF DIVIDERS AND PRODUCT PUSHERS 6

2.0 OVERVIEW	8
--------------	---

2.1 SHELF DIVIDERS	13
--------------------	----

2.1.1. Shelf divider System +S	13
--------------------------------	----

2.1.2. Shelf divider System Standard	18
--------------------------------------	----

2.1.3. Shelf divider System T+C	20
---------------------------------	----

2.1.4. Shelf divider NEON	21
---------------------------	----

2.2 PRODUCT PUSHERS	22
---------------------	----

2.2.1. Product pusher System +S	22
---------------------------------	----

2.2.2. Product pusher System Standard	26
---------------------------------------	----

2.2.3. Product pusher System T	27
--------------------------------	----

2.3 ACCESSORIES FOR DIVIDERS AND PUSHERS	28
---	----

2.3.1. Manual product pushers and product supports	32
---	----

## 3. VARIOTRAY 35

3.1 VARIOTRAY	36
---------------	----

3.2 VARIOTRAY ACCESSORIES	37
---------------------------	----

## 4. T-PROFILE RAILS 38

4.1 T-PROFILE RAILS	38
---------------------	----

4.2 T-PROFILE RAILS FLAT	39
--------------------------	----

4.3 T-PROFILE RAILS WITH UPWARD FRONT	41
---------------------------------------	----

4.4 T-PROFILE RAILS WITH DOWNWARD FRONT	43
---	----

4.5 T-PROFILE RAILS WITH SCANNER PROFILE	43
--	----

## 5. GRAVITY FEED 46

5.1 ROLLER TRACK XL	48
---------------------	----

5.2 ROLLER TRACK STANDARD	48
---------------------------	----

5.3 GLIDING TRACK	50
-------------------	----

## 6. SPECIAL APPLICATIONS 52

6.1 REFRIGERATION	53
-------------------	----

6.2 SRP-PRODUCT PUSHER	55
------------------------	----

6.3 PRIMA PTF	56
---------------	----

## 7. PRIMA 2.0 57

7.0 OVERVIEW	58
--------------	----

7.1 PRODUCT PUSHERS AND ACCESSORIES FOR PRIMA 2.0	59
--	----



# SHELF MANAGEMENT SYSTEMS

## NEWS



### PRIMA GLIDING TRACK – PUSHES YOUR TURNOVER FORWARD

The brand new PRIMA gliding track completes the established OEK shelf management system ideally. At the same time, this innovation presents a consequent further development for your point of sale. The new development shows its strength particularly when used with heavy products. Cans, bottles or PET-bottles with star bottom are magically gliding to the shelf front.



### PRIMA ROLLER SYSTEM XL – PUSHED BY GRAVITY

This system is particularly suitable for heavy products as big beverage bottles, Six-packs or washing powder. With the roller track XL even products, that would be difficult or even impossible to move with conventional systems, will glide to the shelf front easily.

### PRIMA PUSHER – FOR REFRIGERATORS

The new pusher modules for refrigerators of Oechsle now also transfer the advantages of established shelf divider- and pusher systems in your refrigerator. A front of goods without gaps gives your customer a quick review on the offered products and enables him to pick up the requested article quickly. In this way not only turnover of frozen goods can be increased, but also a loss of temperature inside the refrigerator, when taking out products, can be reduced.





**NEW IN OUR RANGE:**

- PRIMA GLIDING TRACK → PAGE 50
- PRIMA ROLLER SYSTEM XL → PAGE 48
- PRIMA PUSHER  
FOR REFRIGERATORS → PAGE 53
- PRIMA PTF → PAGE 56
- PRIMA PUSHER SRP → PAGE 55
- PRIMA 2.0 → PAGE 57

**PRIMA PTF (MANUAL PUSHER "PULL TO FRONT")**  
YOUR PRODUCTS – JUST WITHIN YOUR GRASP

Having taken out a product a gap is left in the shelf, reducing visibility and access to products remaining on the shelf. The new manual pusher made by Oechsle is putting things right: Using the PRIMA PTF (pull to front) means to close such gaps immediately.



**PRIMA PUSHER SRP – EASY SHELF ORGANIZATION**

Just fill delivered goods directly into the shelf without unpacking or repacking. In this case functional covering box of goods is transport and presentation tray in one. Trading applicable SRP packing units make the handling easy and reduce the costs for logistics and shelf care. The Oechsle prima pusher system SRP supports any optimization concept of the retail trade. The easy-to-integrate system brings the goods into the pole position. Completely independent – from the first to the last product.

**PRIMA 2.0 – WIN WITH FLEXIBILITY**

Everything changes and so does your shelf. With the PRIMA 2.0 System a change of shelf layout is quick and easy. Trouble-free you move dividers and pushers to the new position according to the width of the products.



# SHELF MANAGEMENT SYSTEMS

## CONCRETE EXAMPLES





## SHELF DIVIDERS AND PRODUCT PUSHERS

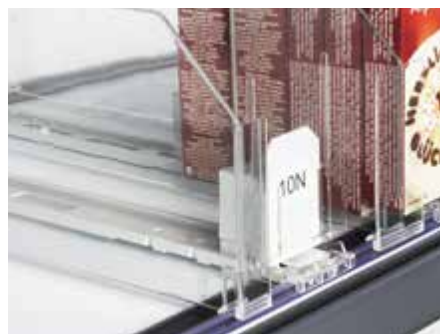
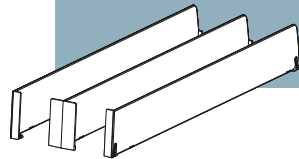

# SHELF DIVIDERS AND PRODUCT PUSHERS

## OVERVIEW

### PRIMA SHELF DIVIDER SYSTEM +S

The PRIMA shelf divider System +S is offering dividers in different lengths, heights and fronts. The dividers get even more variable by breaking points, thus one can adjust length of the dividers to the length of the shelving. For every product the perfect divider.

### PRIMA SHELF DIVIDER SYSTEM +S ARE AVAILABLE AS

- **PRIMA 1** with one fixing point
- **PRIMA 2** with two fixing points, variable lengths by breaking points
- **PRIMA 3** with two fixing points, 80 mm front and in fixed lengths
- **PRIMA 4** with two fixing points in fixed lengths
- **PRIMA 5** with two fixing points, high front (60 and 120 mm) and in fixed lengths

#### PRIMA 1+S

##### PRIMA 1 +S H30

Lengths from 155 to 355 mm every 25 mm (without T-front)

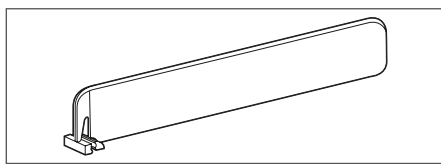

##### PRIMA 1 +S H60

Lengths from 180 to 555 mm every 25 mm (with 20 x 24 mm T-front)

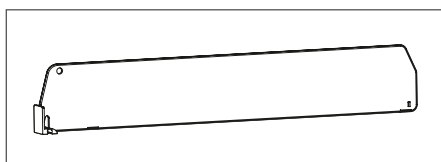

##### PRIMA 1 +S MINI H60

Lengths from 180 to 355 mm every 25 mm (with 12 x 24 mm T-front)

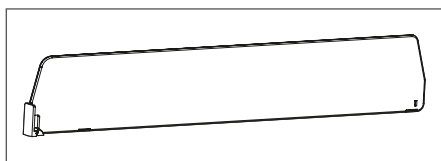

##### PRIMA 1 +S H120

Lengths from 180 to 555 mm every 25 mm (with 20 x 24 mm T-front)

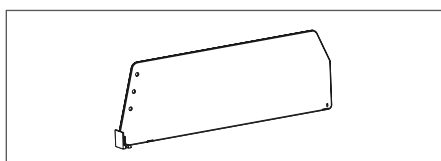

#### PRIMA 2+S

##### PRIMA 2 +S H25

With breaking points from 185 to 335 mm every 25 mm (with 12 x 24 mm T-front)

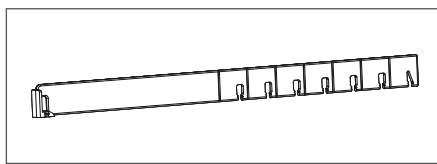

##### PRIMA 2 +S H50

Length 470 mm with one breaking point at 370 mm (with 20 x 24 mm T-front)

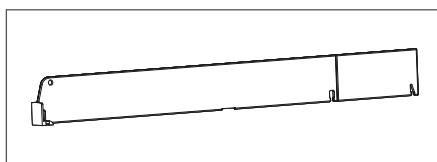

##### PRIMA 2 +S H60

With breaking points from 185 to 335 mm from 285 to 485 mm and from 510 to 635 mm every 25 mm (with 20 x 24 mm T-front)

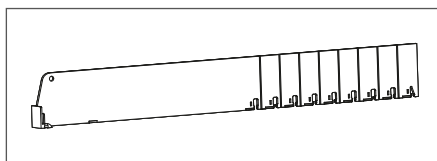

##### PRIMA 2 +S H120

With breaking points from 185 to 335 mm from 285 to 485 mm and from 510 to 635 mm every 25 mm (with 20 x 24 mm T-front)

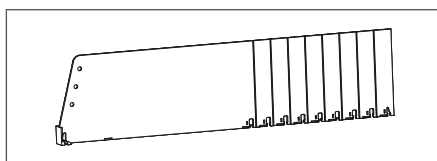

##### PRIMA 2 +S PET H50

With breaking points from 285 to 485 mm every 50 mm (with 25 x 30 mm T-front)

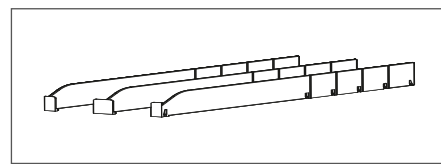

##### PRIMA 2 +S PET H90

With breaking points from 285 to 485 mm every 50 mm (with 25 x 30 mm T-front)

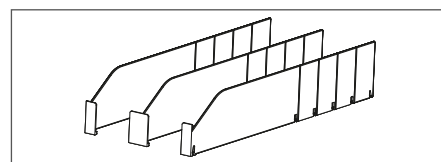



PRIMA dividers are fixed in front (PR1) or both ends (PR2,3,4 und 5) by T-profile rails, whereas dividers type 3 to 5 can be used both ends in front. Thus one can always use the best presentation for the product. A transparent rod filed through the holes of the divider will give certain products a secure front support. Dividers System +S are produced from transparent and break-proof polycarbonate. Dividers PR2 +S with height 50 mm are available in polycarbonate and PET, with height 90 in PET only. For suitable pushers please see page 22 to 25, for accessories see page 28+.

### PRIMA 3+S

**PRIMA 3 +S H120**  
Lengths from 335 to 585 mm every 25 mm  
(optionally with 35 x 80 mm or 20 x 24 mm  
T-front in front)

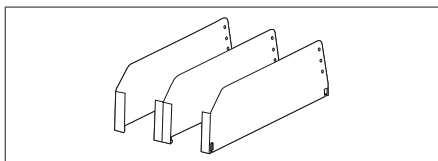

**PRIMA 3 +S H120 20° INCLINED**  
Lengths from 335 to 585 mm every 25 mm  
(optionally with 35 x 80 mm or 20 x 24 mm  
T-front in front)

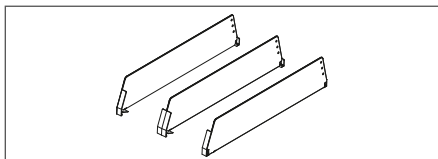

### PRIMA 4+S

**PRIMA 4 +S H30**  
Length 385 mm (without T-front)

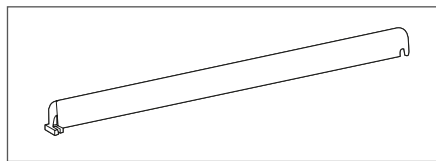

**PRIMA 4 +S H60**  
Lengths from 260 to 560 mm every 25 mm  
(optionally with 12 x 24 mm or 20 x 24 mm  
T-front in front)

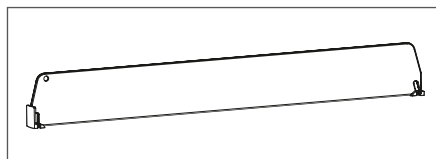

**PRIMA 4 +S H120**  
Lengths from 335 to 585 mm every 25 mm  
(with 20 x 24 mm T-front on both sides)

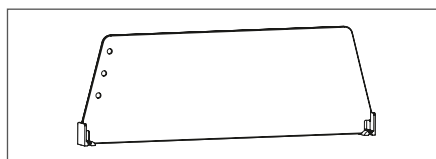

### PRIMA 5+S

**PRIMA 5 +S H60**  
Lengths from 260 to 485 mm every 25 mm  
(optionally with 35 x 60 mm or 12 x 24 mm  
T-front in front)

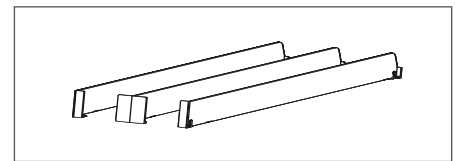

**PRIMA 5 +S H120**  
Lengths from 335 to 585 mm every 25 mm  
(optionally with 35 x 120 mm or 20 x 24 mm  
T-front in front)

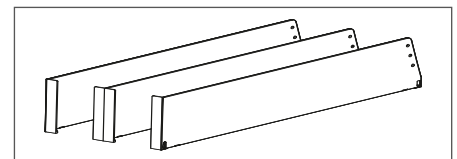

# SHELF DIVIDERS AND PRODUCT PUSHERS

## OVERVIEW

### PRIMA SHELF DIVIDER STANDARD

The PRIMA shelf dividers Standard are characterised by a particularly robust front fixation. They are mainly used as a pure segmentation for products displayed in a shelf. If used with product pushers the merchandise stops at the slightly backspaced front. Fixation by T-profile rails. The shelf dividers Standard are made from transparent and break-proof polycarbonate. For suitable product pushers and accessories please see page 28+.

#### PRIMA 1

PRIMA 1 H60

Lengths from 180 to 555 mm  
every 25 mm

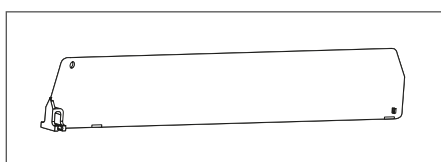

PRIMA 1 H120

Lengths from 180 to 555 mm  
every 25 mm

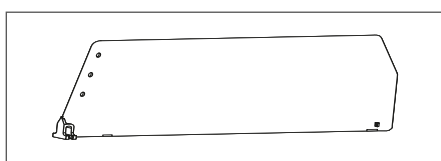

#### PRIMA 2

PRIMA 2 H25

With breaking points from 185 to 335 mm  
from 360 to 485 mm and from 510 to  
635 mm every 25 mm

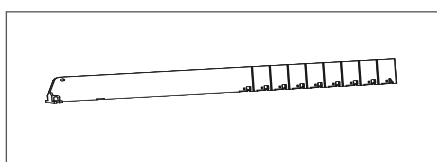

PRIMA 2 H60

With breaking points from 185 to 335 mm  
from 285 to 485 mm and from 510 to  
635 mm every 25 mm

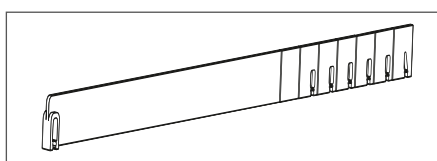

PRIMA 2 H120

With breaking points from 185 to 335 mm  
from 285 to 485 mm and from 510 to  
635 mm every 25 mm

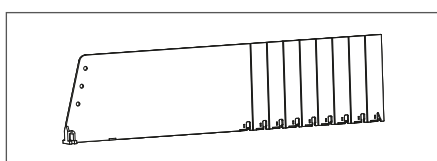

#### PRIMA 4

PRIMA 4 H200

Lengths from 385 to 585 mm  
every 25 mm

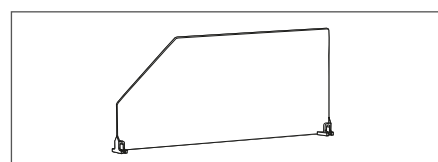

**SHELF DIVIDERS FOR SHELVES WITH FRONT GROOVE AND FOR CONVENIENCE STORES.**

PRIMA shelf divider System „T“ (Tego) is available as

→ **PRIMA 6** in heights 100 and 150 mm

The divider is clamped into the front shelf groove, a T-front 54x41 mm wide and 100 resp. 150 mm high gives stacked products such as writing pads, exercise books etc. a secure hold in inclined as well as in horizontal shelves. Length 300 mm. Dividers System „T“ are made from polystyrene.

**MODELS SYSTEM „T“:**

**PRIMA 6 +T**

PR6 +T H100

Shelf divider Tego for shelves with front groove.

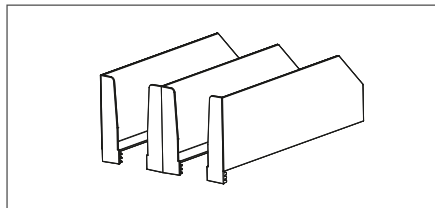

PR6 +T H150

Shelf divider Tego for shelves with front groove.

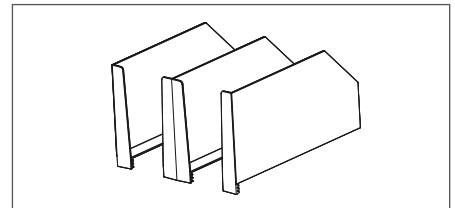

PRIMA shelf divider System „C“ is available as

→ **PRIMA 7** in heights 50 and 80 mm

The dividers have a 35 mm front (respectively 20 mm with left and right divider) and with a 40 mm (respectively 35 mm) magnetic tape on the base they are sticking onto metallic shelves and boards. Especially suitable for convenience stores, kiosk and checkout shelves in short depths and for small products. Made from transparent PET.

**MODELS SHELF DIVIDER SYSTEM „C“:**

**PRIMA 7 +C**

PR7 +C PET H50

Length 255 mm and with 35 mm front (resp. 20 mm for version left/right), with two breaking points at 155 and 205 mm.

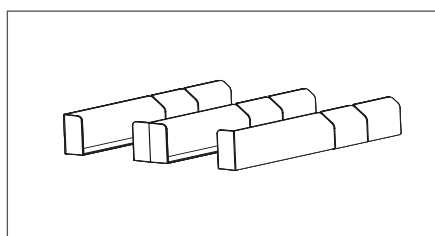

PR7 +C PET H80

Length 255 mm and with 35 mm front (resp. 20 mm for version left/right), with two breaking points at 155 and 205 mm.

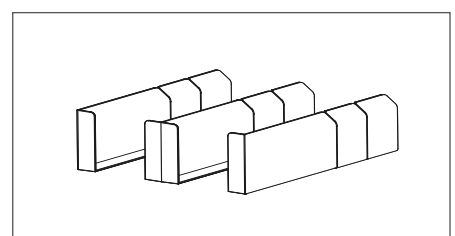

# SHELF DIVIDERS AND PRODUCT PUSHERS

## OVERVIEW

### SUITABLE PRODUCT PUSHERS FOR SHELF DIVIDERS SYSTEM +S

PRV +S H0  
Without front

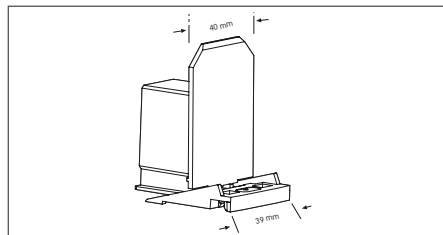

PRV +S H15  
With front 15 mm

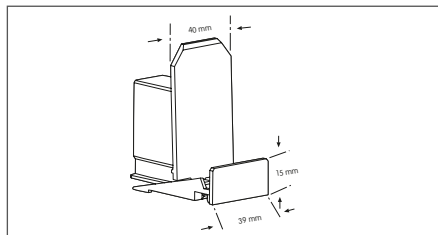

PRV +S H60  
With front 60 mm, 20° inclined

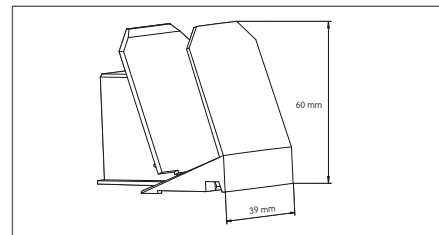

PRV +S SLIM H0  
Without front

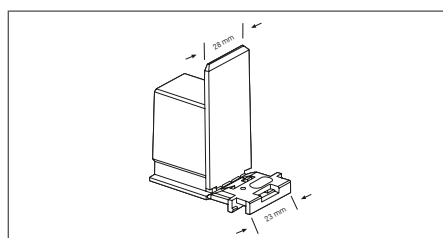

PRV +S H30  
With front 30 mm

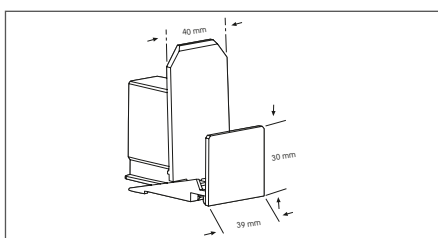

PRV +S SLOW-FEED H30  
Product pusher Slow Feed with damper,  
with front 30 mm

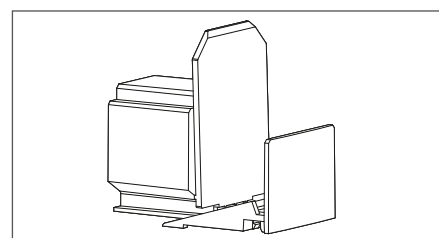

PRV +S SLIM H30  
With front 30 mm

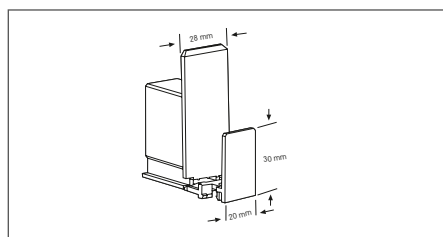

PRV +S MINI  
Housing height 40 mm, without front,  
with sliding rail in lengths 185 - 360 mm  
every 25 mm

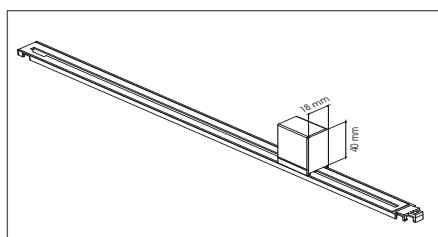

PRV +S MINI  
Housing height 70 mm, without front,  
with sliding rail in lengths 185 - 360 mm  
every 25 mm

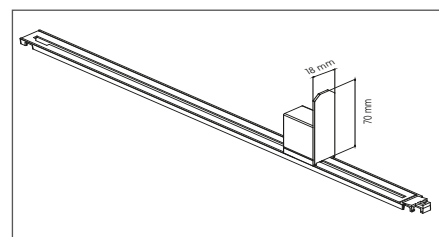

### SUITABLE PRODUCT PUSHERS FOR DIVIDERS SYSTEM STANDARD

PRV H35  
With front 35 mm

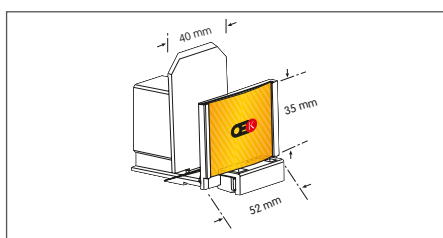

PRV H16  
With front 16 mm

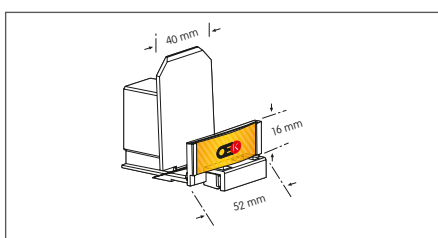

PRV SLIM H35  
With front 35 mm

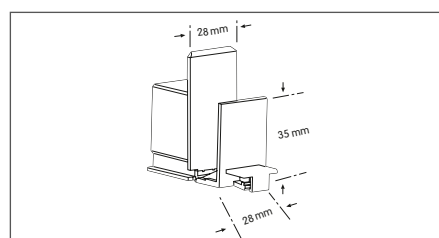

**PRV-T H0**

Product pusher for shelves with front groove (e.g. Tego), without front

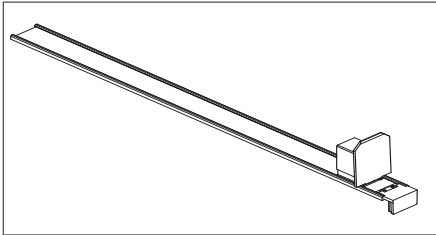

**PRV-T H30**

Product pusher for shelves with front groove (e.g. Tego), front height 30 mm

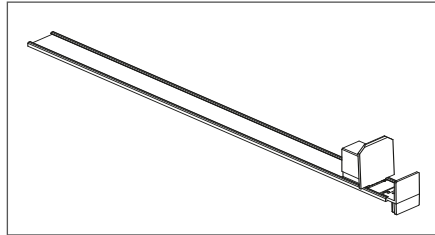

**SHELF DIVIDER PRIMA 1 +S**

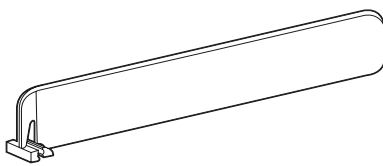

**PRIMA 1 +S H30**

PR1 +S 30/155		40111-88/155
PR1 +S 30/180		40111-88/180
PR1 +S 30/205		40111-88/205
PR1 +S 30/230		40111-88/230
PR1 +S 30/255		40111-88/255
PR1 +S 30/280		40111-88/280
PR1 +S 30/305		40111-88/305
PR1 +S 30/330		40111-88/330
PR1 +S 30/355		40111-88/355

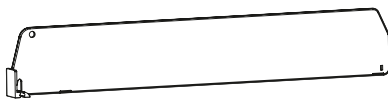

**PRIMA 1 +S H60**

PR1 +S 60/180		40112-88/180
PR1 +S 60/205		40112-88/205
PR1 +S 60/230		40112-88/230
PR1 +S 60/255		40112-88/255
PR1 +S 60/280		40112-88/280
PR1 +S 60/305		40112-88/305
PR1 +S 60/330		40112-88/330
PR1 +S 60/355		40112-88/355
PR1 +S 60/380		40112-88/380
PR1 +S 60/405		40112-88/405
PR1 +S 60/430		40112-88/430
PR1 +S 60/455		40112-88/455
PR1 +S 60/480		40112-88/480
PR1 +S 60/505		40112-88/505
PR1 +S 60/530		40112-88/530
PR1 +S 60/555		40112-88/555



# SHELF DIVIDERS AND PRODUCT PUSHERS

## SHELF DIVIDER SYSTEM +S



### PRIMA 1 +S MINI H60

PR1 +S Mini 60/180		40212-88/180
PR1 +S Mini 60/205		40212-88/205
PR1 +S Mini 60/230		40212-88/230
PR1 +S Mini 60/255		40212-88/255
PR1 +S Mini 60/280		40212-88/280
PR1 +S Mini 60/305		40212-88/305
PR1 +S Mini 60/330		40212-88/330
PR1 +S Mini 60/355		40212-88/355

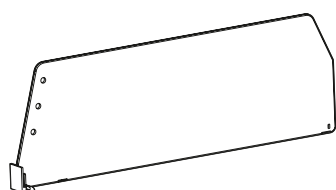

### PRIMA 1 +S H120

PR1 +S 120/180		40115-88/180
PR1 +S 120/205		40115-88/205
PR1 +S 120/230		40115-88/230
PR1 +S 120/255		40115-88/255
PR1 +S 120/280		40115-88/280
PR1 +S 120/305		40115-88/305
PR1 +S 120/330		40115-88/330
PR1 +S 120/355		40115-88/355
PR1 +S 120/380		40115-88/380
PR1 +S 120/405		40115-88/405
PR1 +S 120/430		40115-88/430
PR1 +S 120/455		40115-88/455
PR1 +S 120/480		40115-88/480
PR1 +S 120/555		40115-88/555



## SHELF DIVIDER PRIMA 2 +S

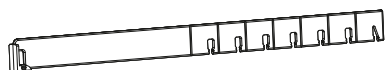

### PRIMA 2 +S H25

40120-88/335

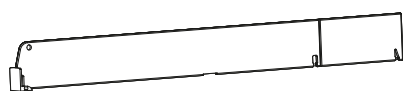

### PRIMA 2 +S H50

40123-88/470/S025

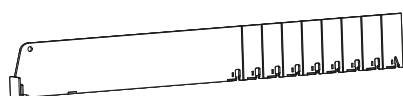

### PRIMA 2 +S H60

PR2 +S 60/335		40122-88/335
PR2 +S 60/485		40122-88/485
PR2 +S 60/635		40122-88/635

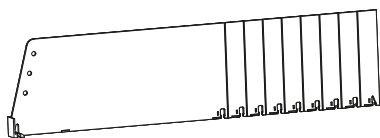

**PRIMA 2 +S H120**

- PR2 +S 120/335 | 40125-88/335
- PR2 +S 120/485 | 40125-88/485
- PR2 +S 120/635 | 40125-88/635

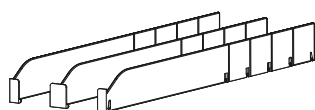

**PRIMA 2 +S PET H50**

- PR2 +S 50/485 | 40123-82/485
- PR2 +S 50/485 left | 40123-82/485L
- PR2 +S 50/485 right | 40123-82/485R

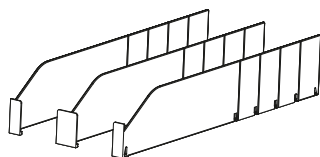

**PRIMA 2 +S PET H90**

- PR2 +S 90/485 | 40127-82/485
- PR2 +S 90/485 left | 40127-82/485L
- PR2 +S 90/485 right | 40127-82/485R



**SHELF DIVIDER PRIMA 3 +S**

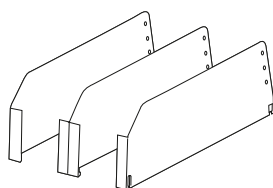

**PRIMA 3 +S H120**

- PR3 +S 120/335 | 40135-88/335
- PR3 +S 120/360 | 40135-88/360
- PR3 +S 120/385 | 40135-88/385
- PR3 +S 120/410 | 40135-88/410
- PR3 +S 120/435 | 40135-88/435
- PR3 +S 120/460 | 40135-88/460
- PR3 +S 120/485 | 40135-88/485
- PR3 +S 120/510 | 40135-88/510
- PR3 +S 120/535 | 40135-88/535
- PR3 +S 120/560 | 40135-88/560
- PR3 +S 120/585 | 40135-88/585



For a neat closing of the sideward shelf edges

- PR3 +S 120/xxx left | 40135-88/xxxL
- PR3 +S 120/xxx right | 40135-88/xxxR

# SHELF DIVIDERS AND PRODUCT PUSHERS

## SHELF DIVIDER SYSTEM +S

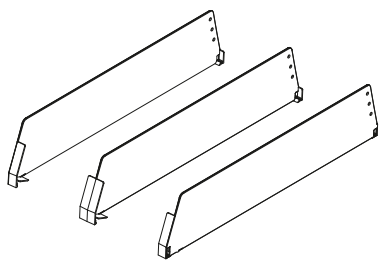

### PRIMA 3 +S H120 20° INCLINED

PR3 +S 120/335		40435-88/335
PR3 +S 120/360		40435-88/360
PR3 +S 120/385		40435-88/385
PR3 +S 120/410		40435-88/410
PR3 +S 120/435		40435-88/435
PR3 +S 120/460		40435-88/460
PR3 +S 120/485		40435-88/485
PR3 +S 120/510		40435-88/510
PR3 +S 120/535		40435-88/535
PR3 +S 120/560		40435-88/560
PR3 +S 120/585		40435-88/585



### PRIMA 3 +S WITH LEFT & RIGHT FRONT SUPPORT

For a neat closing of the sideward shelf edges

PR3 +S 120/xxx		40435-88/xxxL
		left inclined
PR3 +S 120/xxx		40435-88/xxxR
		right inclined

## SHELF DIVIDER PRIMA 4 +S

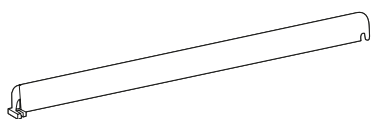

### PRIMA 4 +S H30

40141-88/385

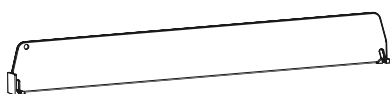

### PRIMA 4 +S H60

PR4 +S 60/260		40142-88/260
PR4 +S 60/285		40142-88/285
PR4 +S 60/310		40142-88/310
PR4 +S 60/335		40142-88/335
PR4 +S 60/360		40142-88/360
PR4 +S 60/385		40142-88/385
PR4 +S 60/410		40142-88/410
PR4 +S 60/435		40142-88/435
PR4 +S 60/460		40142-88/460
PR4 +S 60/485		40142-88/485
PR4 +S 60/510		40142-88/510
PR4 +S 60/535		40142-88/535
PR4 +S 60/560		40142-88/560







**PRIMA 4 +S H120**

PR4 +S 120/335		40145-88/335
PR4 +S 120/360		40145-88/360
PR4 +S 120/385		40145-88/385
PR4 +S 120/410		40145-88/410
PR4 +S 120/435		40145-88/435
PR4 +S 120/460		40145-88/460
PR4 +S 120/485		40145-88/485
PR4 +S 120/510		40145-88/510
PR4 +S 120/535		40145-88/535
PR4 +S 120/560		40145-88/560
PR4 +S 120/585		40145-88/585



**SHELF DIVIDER PRIMA 5 +S**

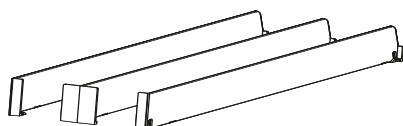

**PRIMA 5 +S H60**

PR5 +S 60/260		40152-88/260
PR5 +S 60/285		40152-88/285
PR5 +S 60/310		40152-88/310
PR5 +S 60/335		40152-88/335
PR5 +S 60 360		40152-88/360
PR5 +S 60/385		40152-88/385
PR5 +S 60/410		40152-88/410
PR5 +S 60/435		40152-88/435
PR5 +S 60/460		40152-88/460
PR5 +S 60/485		40152-88/485

**PRIMA 5 +S H60 WITH LEFT & RIGHT FRONT SUPPORT**

For a neat closing of the sideward shelf edges

PR5 +S 60/xxx left		40155-88/xxxL
PR5 +S 60/xxx right		40152-88/xxxR

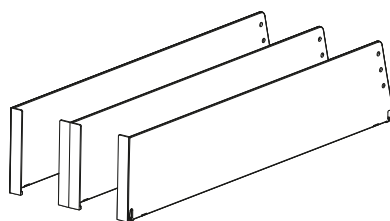

**PRIMA 5 +S H120**

PR5 +S 120/335		40155-88/335
PR5 +S 120/360		40155-88/360
PR5 +S 120/385		40155-88/385
PR5 +S 120/410		40155-88/410
PR5 +S 120/435		40155-88/435
PR5 +S 120/460		40155-88/460
PR5 +S 120/485		40155-88/485
PR5 +S 120/510		40155-88/510
PR5 +S 120/535		40155-88/535
PR5 +S 120/560		40155-88/560
PR5 +S 120/585		40155-88/585

**PRIMA 5 +S H120 WITH LEFT & RIGHT FRONT SUPPORT**

For a neat closing of the sideward shelf edges

PR5 +S 120/xxx left		40152-88/xxxL
PR5 +S 120/xxx right		40155-88/xxxR



# SHELF DIVIDERS AND PRODUCT PUSHERS

## SHELF DIVIDER SYSTEM STANDARD

### SHELF DIVIDER PRIMA 1



#### PRIMA 1 H60

PR1 60/180		40012-88/180
PR1 60/205		40012-88/205
PR1 60/230		40012-88/230
PR1 60/255		40012-88/255
PR1 60/280		40012-88/280
PR1 60/305		40012-88/305
PR1 60/330		40012-88/330
PR1 60/355		40012-88/355
PR1 60/380		40012-88/380
PR1 60/405		40012-88/405
PR1 60/430		40012-88/430
PR1 60/455		40012-88/455
PR1 60/480		40012-88/480
PR1 60/505		40012-88/505
PR1 60/530		40012-88/530
PR1 60/555		40012-88/555



#### PRIMA 1 H120

PR1 120/180		40015-88/180
PR1 120/205		40015-88/205
PR1 120/230		40015-88/230
PR1 120/255		40015-88/255
PR1 120/280		40015-88/280
PR1 120/305		40015-88/305
PR1 120/330		40015-88/330
PR1 120/355		40015-88/355
PR1 120/380		40015-88/380
PR1 120/405		40015-88/405
PR1 120/430		40015-88/430
PR1 120/455		40015-88/455
PR1 120/480		40015-88/480
PR1 120/555		40015-88/555



## SHELF DIVIDER PRIMA 2

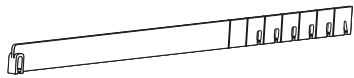

### PRIMA 2 H25

PR2 25/335		40020-88/335
PR2 25/485		40020-88/485
PR2 25/635		40020-88/635

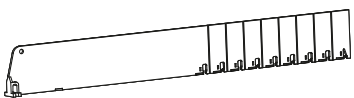

### PRIMA 2 H60

PR2 60/335		40022-88/335
PR2 60/485		40022-88/485
PR2 60/635		40022-88/635

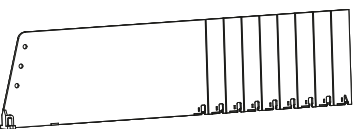

### PRIMA 2 H120

PR2 120/335		40025-88/335
PR2 120/485		40025-88/485
PR2 120/635		40025-88/635



## SHELF DIVIDER PRIMA 4

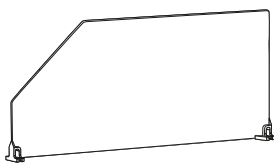

### PRIMA 4 H200

PR4 200/385		40049-88/385
PR4 200/410		40049-88/410
PR4 200/435		40049-88/435
PR4 200/460		40049-88/460
PR4 200/485		40049-88/485
PR4 200/510		40049-88/510
PR4 200/535		40049-88/535
PR4 200/560		40049-88/560
PR4 200/585		40049-88/585



# SHELF DIVIDERS AND PRODUCT PUSHERS

## SHELF DIVIDER SYSTEM T+C

### SHELF DIVIDER PRIMA 6 +T

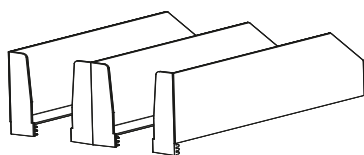

PR6 +T H100  
PR6 +T 100/300 | 40363-84/300  
PR6 +T 100/300 left | 40363-84/300L  
PR6 +T 100/300 right | 40363-84/300R

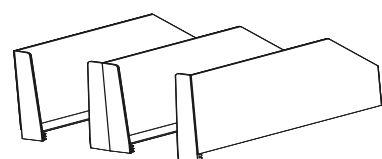

PR6 +T H150  
PR6 +T 150/300 | 40366-84/300  
PR6 +T 150/300 left | 40366-84/300L  
PR6 +T 150/300 right | 40366-84/300R



### SHELF DIVIDER PRIMA 7 +C

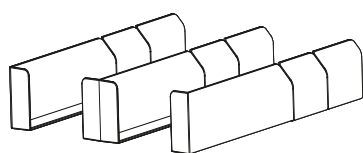

PR7 +C PET H50  
PR7 +C 50/255 | 46450-82/255  
PR7 +C 50/255 left | 46450-82/255L  
PR7 +C 50/255 right | 46450-82/255R

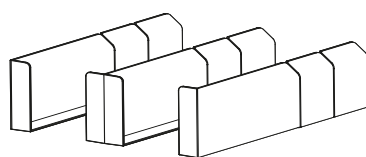

PR7 +C PET H80  
PR7 +C 50/255 | 46480-82/255  
PR7 +C 50/255 left | 46480-82/255L  
PR7 +C 50/255 right | 46480-82/255R



**SHELF DIVIDER NEON**

YOU WOULD LIKE TO HIGHLIGHT A SPECIAL PRODUCT OR PRODUCT GROUP ON THE SHELF?

Neon-dividers made from light-collecting polycarbonate („LISA“) draw the viewers' attention by their colouring.

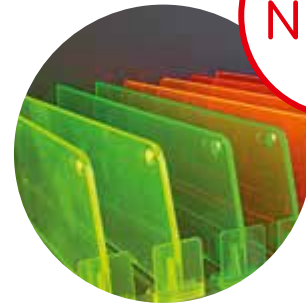

**NEON-DIVIDERS**

- Collecting the surrounding light these dividers are especially suitable for a bright and well lightened environment.
- No need of power supply, to be installed like transparent dividers.
- Dividers can be produced in yellow, orange, pink, green and blue.
- Available upon request.

Shelf dividers NEON for special effects at the POS – please send us your enquiry!

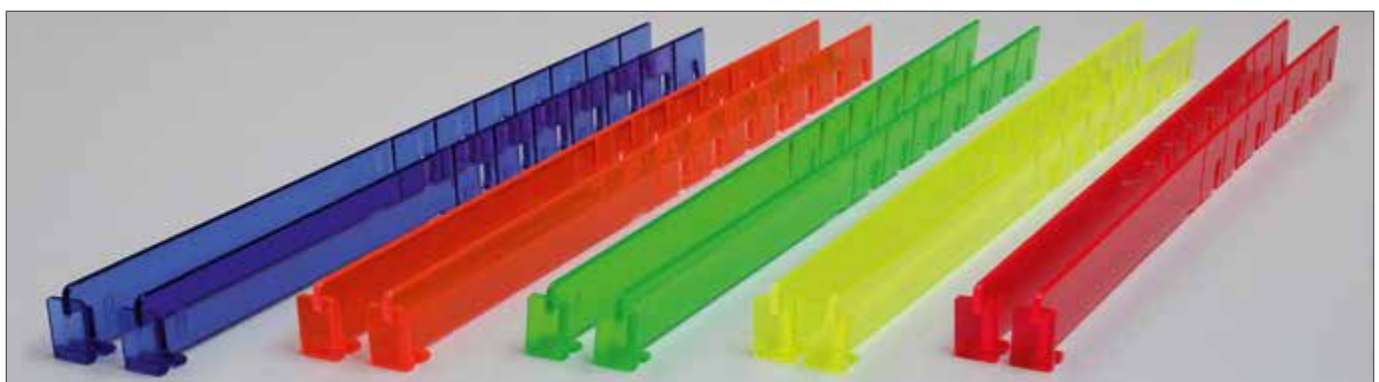

# SHELF DIVIDERS AND PRODUCT PUSHERS

## PRODUCT PUSHER SYSTEM +S

### PRODUCT PUSHER SYSTEM +S

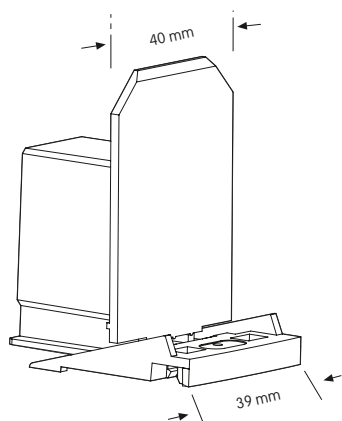

PRV +S H0  
Without front

PRV+S/2 Newton		42508-03/02N
PRV+S/4 Newton		42508-03/04N
PRV+S/6 Newton		42508-03/06N
PRV+S/10 Newton		42508-03/10N
PRV+S/14 Newton		42508-03/14N

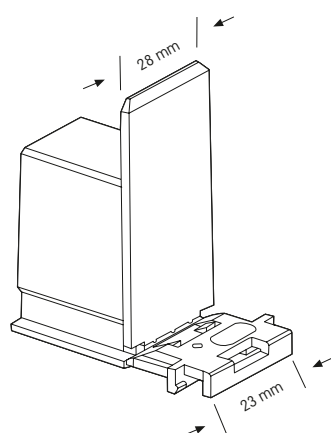

PRV +S SLIM H0  
Without front

PRV+S „Slim“/2 Newton		42004-03/02N
PRV+S „Slim“/4 Newton		42004-03/04N
PRV+S „Slim“/6 Newton		42004-03/06N
PRV+S „Slim“/10 Newton		42004-03/10N

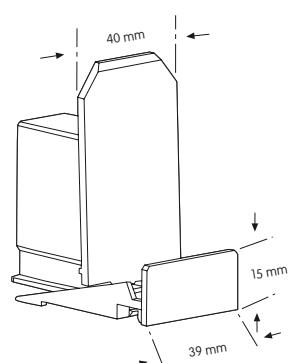

PRV +S H15  
With front 15 mm

PRV+SF H15/2 Newton		42507-03/02N
PRV+SF H15/4 Newton		42507-03/04N
PRV+SF H15/6 Newton		42507-03/06N
PRV+SF H15/10 Newton		42507-03/10N
PRV+SF H15/14 Newton		42507-03/14N

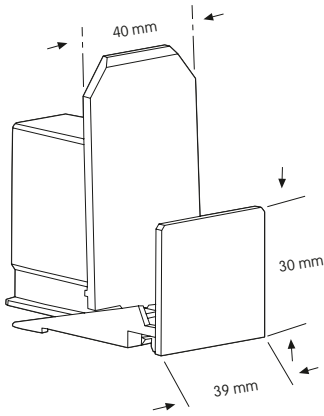

PRV +S H30  
With front 30 mm

- PRV+SF H30/2 Newton | 42506-03/02N
- PRV+SF H30/4 Newton | 42506-03/04N
- PRV+SF H30/6 Newton | 42506-03/06N
- PRV+SF H30/10 Newton | 42506-03/10N
- PRV+SF H30/14 Newton | 42506-03/14N

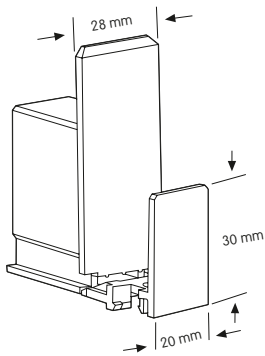

PRV +S SLIM H30  
With front 30 mm

- PRV+SF „Slim“ H30/2 Newton | 42002-03/02N
- PRV+SF „Slim“ H30/4 Newton | 42002-03/04N
- PRV+SF „Slim“ H30/6 Newton | 42002-03/06N
- PRV+SF „Slim“ H30/10 Newton | 42002-03/10N

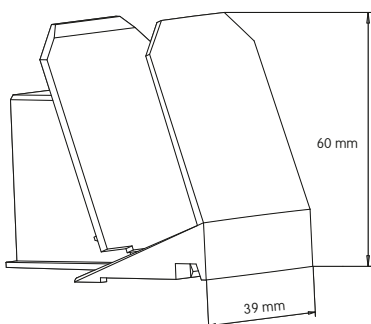

PRV +S H60  
With front 60 mm, 20° inclined

- PRV+SF H60/2 Newton | 42610-03/02N
- PRV+SF H60/4 Newton | 42610-03/04N
- PRV+SF H60/6 Newton | 42610-03/06N
- PRV+SF H60/10 Newton | 42610-03/10N
- PRV+SF H60/14 Newton | 42610-03/14N
- PRV-SF H60/8-4 Newton | 42610-03/8/4N



# SHELF DIVIDERS AND PRODUCT PUSHERS

## PRODUCT PUSHER SYSTEM +S

### PRODUCT PUSHER MINI

The product pusher MINI is especially suitable for very slim products starting from a minimum width of 20 mm (in combination with shelf divider PR1 +S Mini) or 25 mm (in combination with shelf divider PR1+S 30). Pushers are available with 2N, 4N and 6N springs. With integrated sliding rail available in lengths 185 - 360 mm, every 25 mm. In addition to the standard pusher housing in height 40 mm, a 70 mm high housing is available, which is especially designed for high products giving them a secure hold.

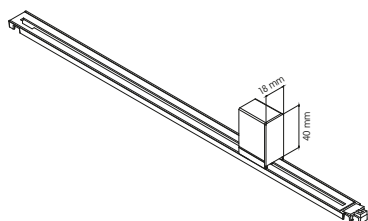

PRV +S MINI

- PRV +S „Mini“ H40/2 Newton | 47211-00/xxx
- PRV +S „Mini“ H40/4 Newton | 47212-00/xxx
- PRV +S „Mini“ H40/6 Newton | 47213-00/xxx

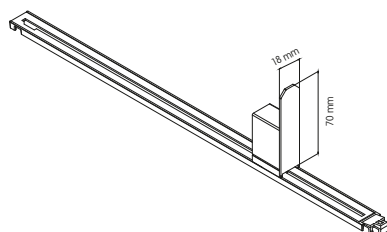

PRV +S MINI

- PRV +S „Mini“ H70/2 Newton | 47221-00/xxx
- PRV +S „Mini“ H70/4 Newton | 47222-00/xxx
- PRV +S „Mini“ H70/6 Newton | 47223-00/xxx

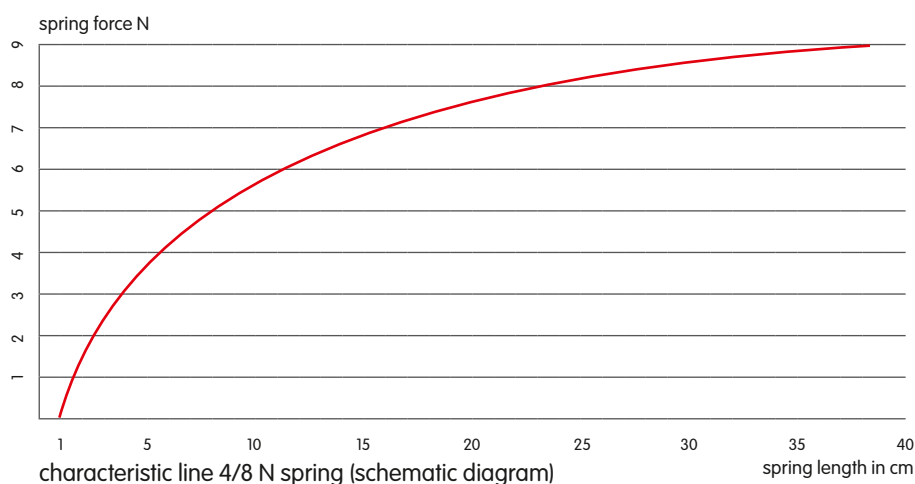
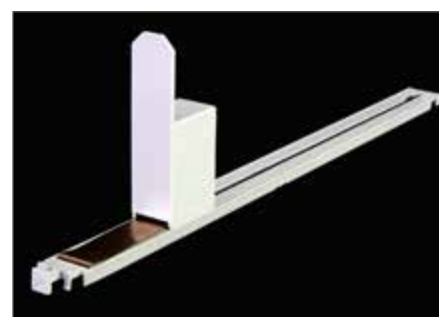

### PRODUCT PUSHER WITH PROGRESSIVE SPRING FORCE

The full power of 8N ensures the necessary push in a full shelf, while the last remaining products after approx. 2/3 of the spring length are gently pushed forward with an adjusted force of just 4N. Especially recommended for shelf depths with more than 400 mm. Available upon request for all product pushers from the PRIMA range.

### PRODUCT PUSHER WITH SPRING 8/4N

Upon request





### SLOW FEED - THE DAMPERED PRODUCT PUSHER

The special product pusher: With strong 10N spring but still gentle when used with sensitive products. A special cushion makes sure that the products are gently pushed forward to the shelf edge. No „snapping“ after quick removal of heavy products such as glass bottles. No problem for stacked products as well, when using SLOW FEED: gently the products are moving forward, making the best use of given shelf space.

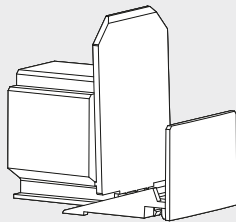

PRV +S SLOW-FEED H30  
Product pusher Slow Feed with damper,  
with front 30 mm

PRV+SF H30/6 Newton		42706-03/06N/10
PRV+SF H30/10 Newton		42706-03/10N/12
PRV+SF H30/10 Newton		42706-03/10N/13
PRV+SF H30/10 Newton		42706-03/10N/14



**Slow Feed** - a pusher with add-on benefit: In combination with a transparent cover, made by our Partner WERBA print, it is a safe protection against professional thieves. As packages slide forward only very slowly, it will be impossible to take more than one pack in one grasp. The products are safe but not stored away. Attractively placed and easy to reach by customers.

# SHELF DIVIDERS AND PRODUCT PUSHERS

## PRODUCT PUSHER SYSTEM STANDARD

### PRODUCT PUSHER STANDARD

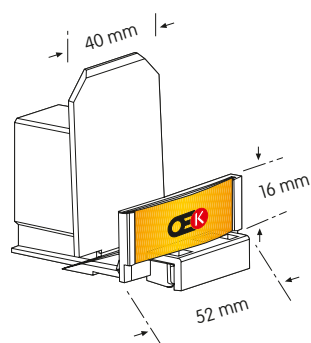

#### PRV H16

With insert for labels with logo and product information size 50 x 13 mm.

With front 16 mm

PRV-16/2 Newton		42501-03/02N
PRV-16/4 Newton		42501-03/04N
PRV-16/6 Newton		42501-03/06N
PRV-16/10 Newton		42501-03/10N
PRV-16/14 Newton		42501-03/14N

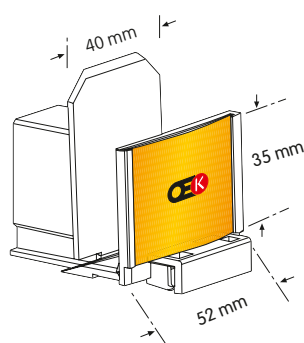

#### PRV H35

With insert for labels with logo and product information size 50 x 30 mm.

With front 35 mm

PRV-35/2 Newton		42500-03/02N
PRV-35/4 Newton		42500-03/04N
PRV-35/6 Newton		42500-03/06N
PRV-35/10 Newton		42500-03/10N
PRV-35/14 Newton		42500-03/14N

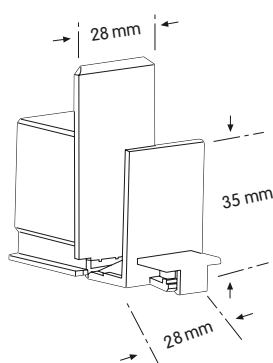

#### PRV SLIM H35

With front 35 mm and housing 28 mm

PRV-35 „Slim“/2 Newton		42003-03/02N
PRV-35 „Slim“/4 Newton		42003-03/04N
PRV-35 „Slim“/6 Newton		42003-03/06N



## PRODUCT PUSHER SYSTEM T

Pusher for shelves with front groove (e.g. Tego). To be used with dividers PRIMA 6 +T.  
Works without profile rail, suitable for shelf grooves 6.5 to 7 mm wide.

### PRV-T H0

Product pusher for shelves with front groove (e.g. Tego), without front

PRV-T H0		42513-03/02N
PRV-T H0		42513-03/04N
PRV-T H0		42513-03/06N
PRV-T H0		42513-03/10N
PRV-T H0		42513-03/14N



### PRV-T H30

Product pusher for shelves with front groove (e.g. Tego), front height 30 mm

PRV-TF H30		42514-03/02N
PRV-TF H30		42514-03/04N
PRV-TF H30		42514-03/06N
PRV-TF H30		42514-03/10N
PRV-TF H30		42514-03/14N



# SHELF DIVIDERS AND PRODUCT PUSHERS

## ACCESSORIES FOR SHELF DIVIDERS AND PRODUCT PUSHERS

### ACCESSORIES FOR PRODUCT PUSHERS

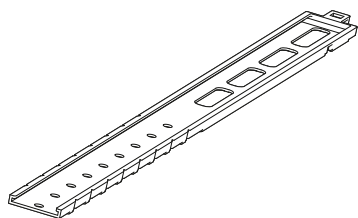

#### SLIDING RAIL SYSTEM S

Length 475 mm breakable in 25 mm steps down to 275 mm, suitable for dividers System +S in lengths 285 to 485 mm. Plastic grey, width 30 mm, height 6 mm.

48920-03/275-475

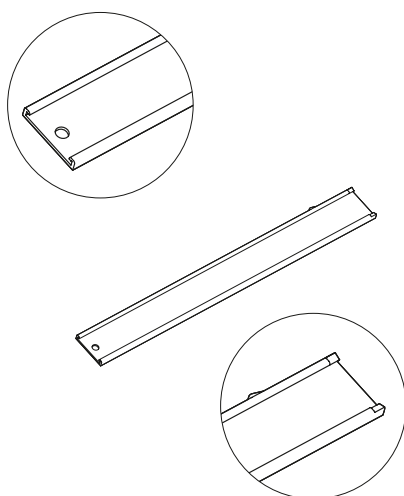
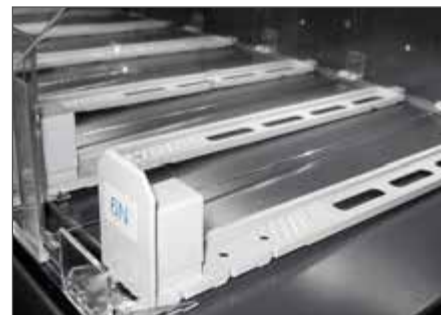

#### SLIDING RAIL

Alternatively for use in displays an extruded sliding rail is available: either WITH end punch of the rear profile edge (to prevent the threading out of the pusher housing), resp. WITHOUT end punch (when fixing the profile in the back with the end clip). Colour grey, width 30 mm.

The exact length for your application is determined by us, dependant on the used pusher- and divider type.

With end punch | 48900-00/xxx

Without end punch | 48901-00/xxx



#### END CLIP FOR SLIDING RAIL STANDARD

Clip for fixing of the sliding rail into the backward profile rail, transparent.

84-48025-00



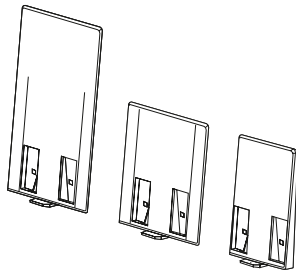

**REAR ENLARGEMENT TRANSPARENT,  
WITH LABEL HOLDER FOR HOUSING  
B40**

To provide a perfect support of the pushed products, to be clicked onto the pusher's housing, transparent. Inserted product facings and labels are securing the shelf space and are easing the shelf maintenance for the staff.

- 49 x 80 mm | 48567-00
- 75 x 80 mm | 48568-00
- 75 x 130 mm | 48569-00

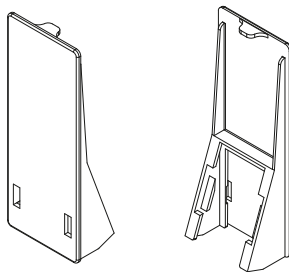

**REAR ENLARGEMENT 50 X 130 MM,  
INCLINED/VERTICAL**

Rear enlargement for housing B40. To be used in inclined or vertical position. Colour grey.

48563-03

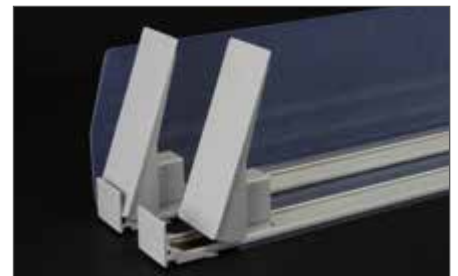
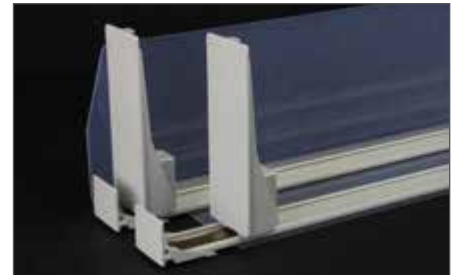

**REAR ENLARGEMENT 75 X 130 MM,  
INCLINED/VERTICAL**

Rear enlargement for housing B40. To be used in inclined or vertical position. Colour grey.

Upon request | 48560-03

# SHELF DIVIDERS AND PRODUCT PUSHERS

## ACCESSORIES FOR SHELF DIVIDERS AND PRODUCT PUSHERS

### ACCESSORIES FOR SHELF DIVIDERS

#### FIXING RAIL FOR PRIMA

Length 297,5 mm, width 24 mm, with „section comb“ 6 mm; to be used at the shelf rear. Holds the shelf divider PR1 in line, without adhesive tape, grey.

Upon request also available with magnetic tape or self adhesive tape.

49094-03

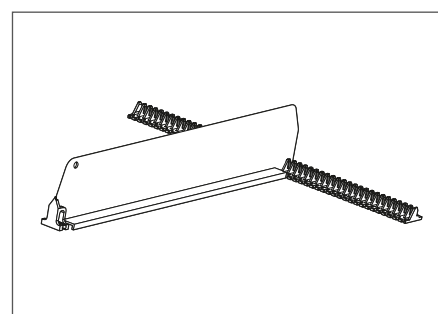
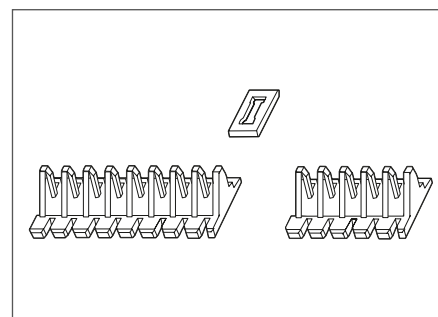

#### FIXING RAIL FLAT

For rear fixing of dividers PR1, measurements 5,25 x 20 x 249 mm, to be mounted with double adhesive tape. Special clips ensure a secure hold of dividers height 120 mm.

Fixing rail flat | 49093-00/K  
Clip to hold shelf divider PR1 | 49095-00

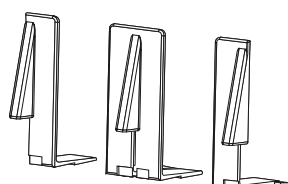

#### FRONT STOPPER FOR DIVIDER STANDARD

This front stopper provides the possibility to upgrade all shelf dividers with height 60 and 120 mm to the PR3 solution.

Front stopper left | 44990-88-L  
Front stopper centre | 44990-88-M  
Front stopper right | 44990-88-R



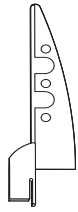

**SHOPPER STOPPER PRIMA FOR DIVIDERS STANDARD**

For mounting onto shelf dividers PR1 (only recommended when fixed at the rear) and PR2, height 60 and 120 mm, transparent.

17440-00

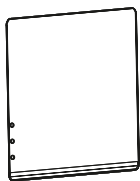

**POSTER POCKET 20 X 20 CM WITH 3 HOLES**

To be used with PRIMA shopper stopper, with 3 holes to clamp, for a secure hold, PVC non-reflective, transparent. Further sizes available upon request.

29600-0007/04



**SQUARE DIVIDER**

For additional subdivision of each compartment between two dividers. To be clicked onto shelf dividers height 60 mm, PVC transparent. Height 55 mm. Width 50 mm. Special sizes available upon request.

46200-00



# SHELF DIVIDERS AND PRODUCT PUSHERS

## MANUAL PRODUCT PUSHERS AND PRODUCT SUPPORTS

### MANUAL PRODUCT PUSHERS

Product support and pushing assisted by a pull-strip, recommended for slim and instable product packages, that shall be presented in an attractive and slightly inclined position (e.g. sliced meat and cheese, instant soups, spices, etc.) or for sensitive products, which could be damaged by using a product pusher with high spring force (e.g. chocolate, chips etc.). The backrest slides smoothly in the stair and can be used with the vertical (for cans and boxes) or the slightly inclined (for soft packages) front forwards. The pull strip is filed through the base of the backrest and the whole unit is clipped onto the T-profile rail. For wide products we recommend to use additional sliding profiles, which are clicked underneath the shelf divider and thus prevent a sideward tipping of the product.

As front support for the products you can either use a reling or a combination with PR3 or PR5 with front.

We recommend to fix the dividers at both ends.

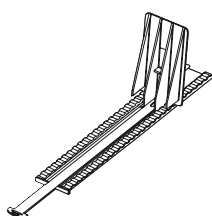

MANUAL PUSHER 3-PARTS  
Width of stair 50 mm, size of backrest  
120 x 65 mm

Length 365 mm | 46901-55  
Length 465 mm | 46902-55



SLIDING RAIL FOR MANUAL PUSHER.  
Width 42 mm, grey.

Length 335 mm | 49092-03/335  
Length 435 mm | 49092-03/435



### PRODUCT SUPPORT WITHOUT PUSHER

Combination of stair and different backrests, which securely support instable product packages and present them in sight of the customer.

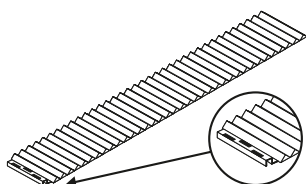

PRODUCT STOPPER PRST  
Length 517 mm, width 56,5 mm,  
adjustable length by predetermined  
breaking points every 55 mm, transparent.

49002-88

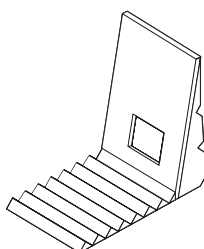

PRRW-A  
Backrest for product stopper, fixed in  
requested position. Simply to be placed  
onto the product stopper. Width/height/  
depth 60 x 115 x 120 mm, transparent

49001-88





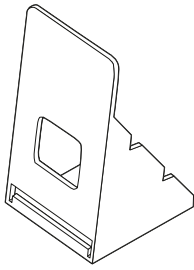

**PRRW-B**  
Backrest for product stopper with special stability to support products, to be slid over the product stopper,  
Width/height/depth 60 x 120 x 60 mm,  
transparent.

49003-88

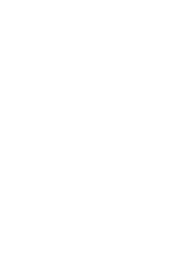
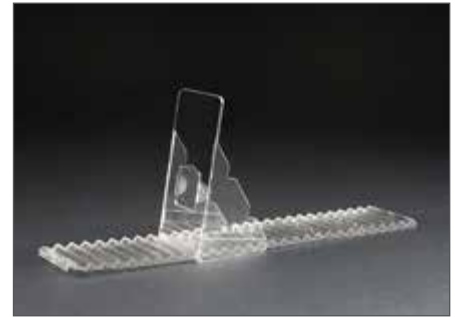

**PRRW-C**  
Backrest for product stopper with special stability to support products.  
Width/height/depth 60 x 160 x 60 mm,  
transparent.

49005-88

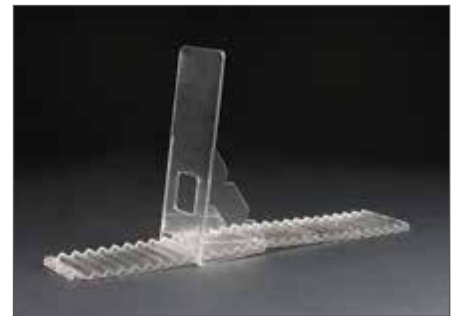

**MAGNETIC BACK SUPPORT SMALL FOR C-DIVIDERS**  
Small back support with magnetic base to be used with C-dividers. Base 80 x 45 mm, height 100 mm, transparent.  
Made from PET.

Upon request | 46490-82

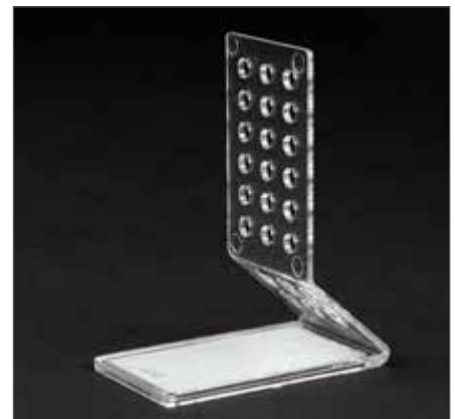

**MAGNETIC BACK SUPPORT LARGE**  
Large back support made from PET to be used as support for instable packages like sliced sausage and cheese in fridges.  
Base completely covered with a magnetic pad. Width/height/depth 90 x 150 x 130 mm, transparent.

49006-82



## SHELF DIVIDERS AND PRODUCT PUSHERS

### MANUAL PRODUCT PUSHERS AND PRODUCT SUPPORTS

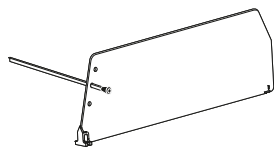

**RELING Ø 5 MM FOR DIVIDERS**  
The reling prevents the goods from tipping over or falling forward, especially in combination with manual pusher, transparent. Other lengths available upon request.

Length 995 mm | 48590-00/0995

Length 1245 mm | 48590-00/1245

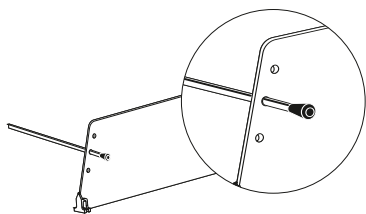

**END CAP FOR RELING**

Colour: black

48599-10



**FRONT AND BACK SUPPORT FOR INDIVIDUALLY SIZED DIVIDERS**  
Front and back support for individually sized dividers. Especially suitable for bottom shelf in refrigerators or for segmenting sales counters. The front and back supports are fixed on both sides onto T-profile rails, the dividers are cut from 3 or 5 mm material (PS or PET) according to a special design to suit the supports. Special sizes or printing available upon request. Width/height 60 x 150 mm

Front and back support | 46700-88

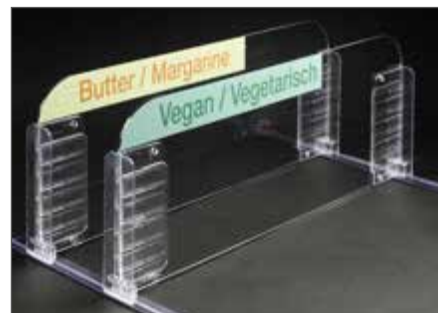



**oechsle display systems**  
*reliable and innovative*

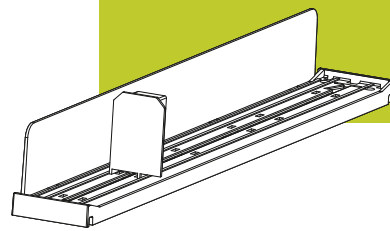

## VARIOTRAY



# VARIOTRAY

## VARIOTRAY

### VARIOTRAY

OEK-Variotray - especially developed for products which need a sideways guiding due to their shape (e.g. cans). The integrated divider avoids a sliding away of (round) products. Variable in length and width and with an asymmetric housing B30 (width 30 mm) in height 40 mm or 70 mm the Variotray adjust itself to products up to a width of approx. 38 to 70 mm without any problems.

The version with small bottom support provides a secure hold for wider products. So the Variotray is „THE“ solution for small, similar products like e.g. spices, baking ingredients or health and beauty products. The Variotrays are fixed with T-profile rails in shelf front. Simple lift up the tray and put it in right position, then lay down and clamp it on rear mounted fixing rails (page 37). Thus changes in shelf layout are easy to handle. Inserted fronts in 2 widths or a T-profile rail with upward front ensure the stop of goods at shelf front. Clip-ons for pusher housings can take product labels, securing the space in the shelf.

The Variotray is available in lengths: 210 mm, 235 mm, 260 mm, 285 mm, 310 mm, 335 mm, 360 mm, 385 mm and 460 mm and each with or without left bottom support (when ordering only put an „A“ at the end of item code (e.g. 46813/210 A).

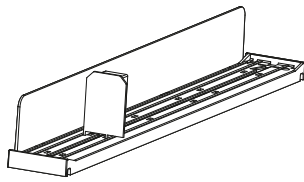
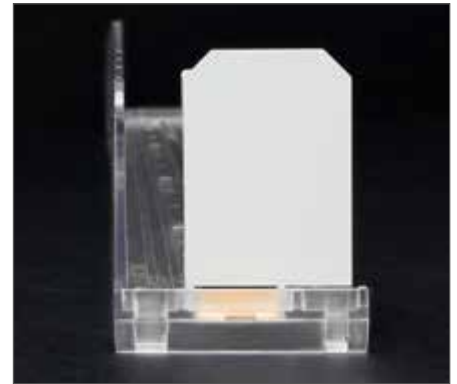
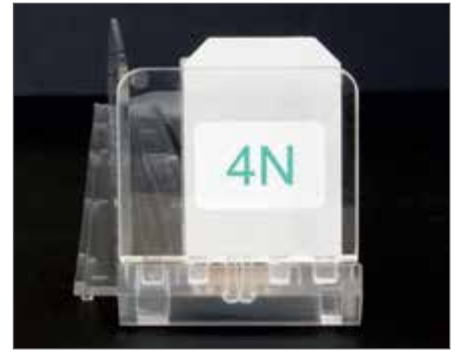

VARIOTRAY, HOUSING  
HEIGHT 40 MM

2N		46811-88/XXX
2N, 460 mm		46821-88/460
4N		46812-88/XXX
4N, 460 mm		46822-88/460
6N		46813-88/XXX
6N, 460 mm		46823-88/460
8-4N		46815-88/XXX
8-4N, 460 mm		46815-88/460
10N		46814-88/XXX
10N, 460 mm		46824-88/460

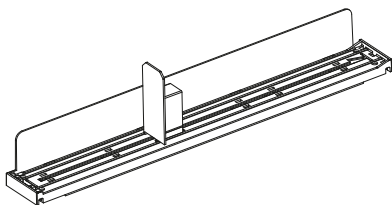

VARIOTRAY, HOUSING  
HEIGHT 70 MM

2N		46831-88/XXX
4N		46832-88/XXX
6N		46833-88/XXX
8-4N		46836-88/XXX
10N		46834-88/XXX

Variotray with bottom support is also available in every length. When ordering only put an „A“ at the end of item code: e.g. 46831-88/210 A



VARIOTRAY ACCESSORIES

VARIOTRAY END PIECE

Width 20,7 mm. Available lengths: 210 mm, 235 mm, 260 mm, 285 mm, 310 mm, 335 mm, 360 mm, 385 mm and 460 mm

Without bottom support | 46809-88/XXX  
With bottom support | 46809-88/XXX A



FIXING RAIL FLAT

To fix Variotrays in the rear. Advantage: Variotrays can be easily adjusted in shelf. Measurements 5,25 x 20 x 249 mm, to be mounted with double adhesive tape.

Fixing rail flat | 49093-00/K

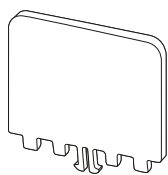
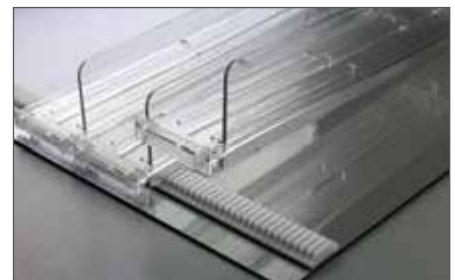

FRONT FOR VARIOTRAY  
Width 43 mm, transparent, measurements: 43 x 40 mm

48710-00/043

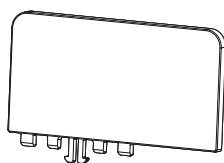

FRONT FOR VARIOTRAY  
Width 68 mm, transparent, measurements: 68 x 40 mm

48710-00/060

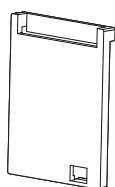

LABELHOLDER FOR VARIOTRAY B30  
Front clips for asymmetric housing height 40 mm to insert product labels size 26 x 38 mm to secure the space in shelf, transparent.

48575-00





## T-PROFILE RAILS

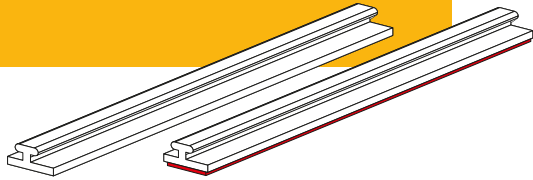

T-profile rails are used to fix dividers on the shelf at the front or at both shelf ends. There are four different versions available:

- T-profile rails flat without edges
- T-profile rails with upward front edge
- T-profile rails with downward front edge
- T-profile rails with scanner profile

## T-PROFILE RAILS FLAT

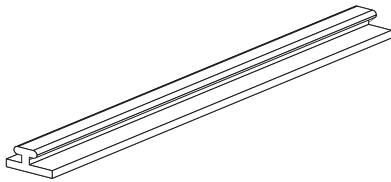

**PRT-10-K**  
T-profile rail with adhesive tape 9 mm,  
width 10 mm, transparent.

Shelf length 1000 mm | 49010-00-K/0998  
Shelf length 1250 mm | 49010-00-K/1248

---

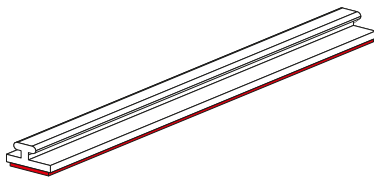

**PRT-13-M**  
T-profile rail with magnetic tape 13 mm,  
width 13 mm, transparent.

Shelf length 1000 mm | 49013-00-M/0998  
Shelf length 1250 mm | 49013-00-M/1248

---

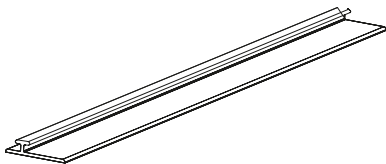

**PRT-20-K**  
T-profile rail with adhesive tape 19 mm,  
width 20 mm, transparent.

Shelf length 1000 mm | 49015-00-K/0998  
Shelf length 1250 mm | 49015-00-K/1248

---

**PRT-20-M**  
T-profile rail with magnetic tape 20 mm,  
width 20 mm, transparent.

Shelf length 1000 mm | 49015-00-M/0998  
Shelf length 1250 mm | 49015-00-M/1248

---

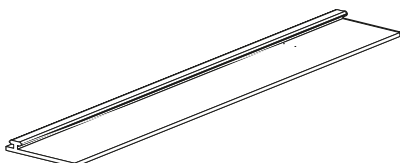

**PRT-30-K**  
T-profile rail with adhesive tape 25 mm,  
width 30 mm, transparent.

Shelf length 1000 mm | 49020-00-K/0998  
Shelf length 1250 mm | 49020-00-K/1248

---

## T-PROFILE RAILS

### T-PROFILE RAILS FLAT

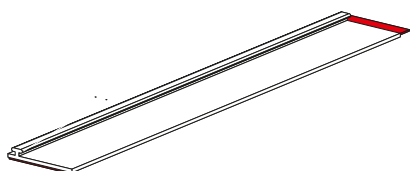

#### PRT-30-M TRANSPARENT

T-profile rail with magnetic tape 25 mm, width 30 mm, transparent.

Shelf length 1000 mm | 49020-00-M/0998

Shelf length 1250 mm | 49020-00-M/1248

#### PRT-30-M SIGNAL GREY

Signal grey RAL7004

Shelf length 1000 mm | 49020-7004-M/0998

Shelf length 1250 mm | 49020-7004-M/1248

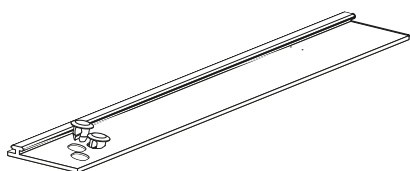

#### PRT-30-L

T-profile rail with hole for wire shelves, transparent. Fixing clips to be ordered separately.

Shelf length 1000 mm | 49020-00-L/0998

Shelf length 1250 mm | 49020-00-L/1248

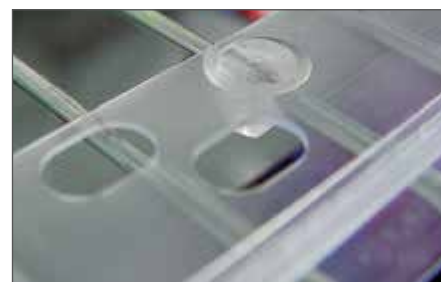

#### FIXING CLIPS

Packed 100 pcs. per bag, transparent.

for wire-Ø 2-3 mm | 49096-00

for wire-Ø 3-4 mm | 49096-00/4



#### PRT-40-K

T-profile rail with adhesive tape 38 mm and adaptor to take a 3 mm thick acrylic front, transparent.

Acrylic fronts in suitable lengths and heights can be produced upon request.

Shelf length 1000 mm | 49089-00-K/0998

Shelf length 1250 mm | 49089-00-K/1248

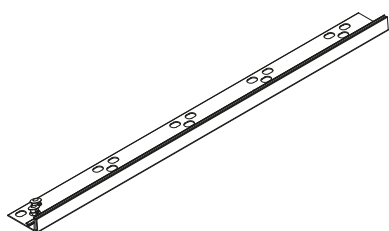

#### PRT-40-L

T-profile rail with holes for wire shelves, adaptor to take a 3 mm thick acrylic front, transparent. Acrylic fronts in suitable lengths and heights can be produced upon request. Fixing clips to be ordered separately.

Shelf length 1000 mm | 49089-00-L/0998

Shelf length 1250 mm | 49089-00-L/1248



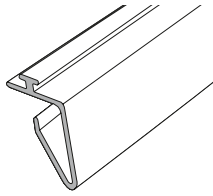

**PRKL**  
T-profile-clamp rail for shelves with front groove (e.g. Tego), transparent.

Shelf length 1000 mm | 49045-00/0988  
Shelf length 1250 mm | 49045-00/1238

**PRKL-S CLAMP RAIL FOR TEGO**  
985 mm, suitable to take 1 mm PET fronts, transparent.

PRKL-S | 49050-00/0985



## T-PROFILE RAILS WITH UPWARD FRONT

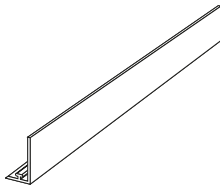

**PRAU-30-SLIM-K**  
T-profile rail with upward front 30 mm and adhesive tape 12 mm, transparent.

Shelf length 1000 mm | 49025-00-K/0998  
Shelf length 1250 mm | 49025-00-K/1248

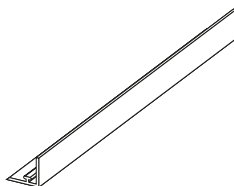

**PRAU-30-K**  
T-profile rail with upward front 30 mm and adhesive tape 25 mm, transparent.

Shelf length 1000 mm | 49030-00-K/0998  
Shelf length 1250 mm | 49030-00-K/1248

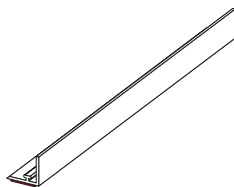

**PRAU-30-M**  
T-profile rail with upward front 30 mm and magnetic tape 25 mm, transparent.

Shelf length 1000 mm | 49030-00-M/0998  
Shelf length 1250 mm | 49030-00-M/1248

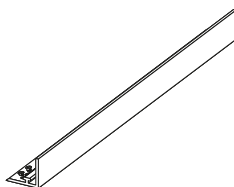

**PRAU-30-L**  
T-profile rail with upward front 30 mm and holes for wire shelves, transparent. Fixing clips to be ordered separately.

Shelf length 1000 mm | 49030-00-L/0998  
Shelf length 1250 mm | 49030-00-L/1248

## T-PROFILE RAILS

### T-PROFILE RAILS WITH UPWARD FRONT

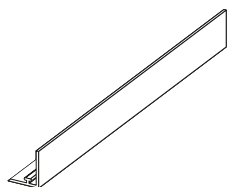

#### PRAU-39-K

T-profile rail with upward front 39 mm and adhesive tape 25 mm, transparent.

Shelf length 1000 mm | 49035-00-K/0998

Shelf length 1250 mm | 49035-00-K/1248

---

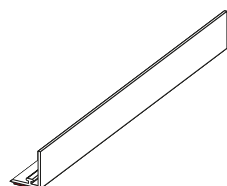

#### PRAU-39-M

T-profile rail with upward front 39 mm and magnetic tape 25 mm, transparent.

Shelf length 1000 mm | 49035-00-M/0998

Shelf length 1250 mm | 49035-00-M/1248

---

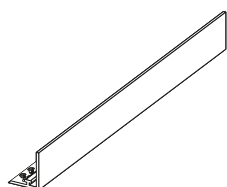

#### PRAU-39-L

T-profile rail with upward front 39 mm and holes for wire shelves, transparent. Fixing clips to be ordered separately.

Shelf length 1000 mm | 49035-00-L/0998

Shelf length 1250 mm | 49035-00-L/1248

---



#### FIXING CLIPS

Packed 100 pcs. per bag, transparent.

for wire-Ø 2-3 mm | 49096-00

for wire-Ø 3-4 mm | 49096-00/4

---

#### PRAU-60-K

T-profile rail with upward front 60 mm and foam adhesive tape, transparent.

Shelf length 1000 mm | 49040-00-K/0998

Shelf length 1250 mm | 49040-00-K/1248

---

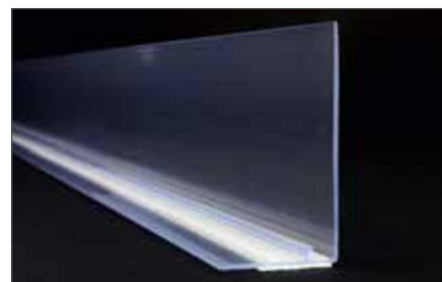

## T-PROFILE RAILS WITH DOWNWARD FRONT

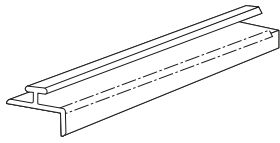

### PRAB-8-K

T-profile rail with downward front 8 mm and adhesive tape 9 mm, transparent. Offering a very secure fit in combination with product pushers.

Shelf length 1000 mm | 49055-00-K/0998

Shelf length 1250 mm | 49055-00-K/1248

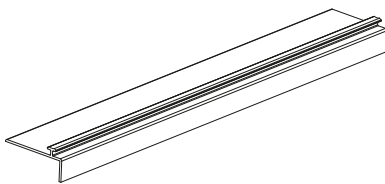

### PRAB-10-K/M

T-profile rail with downward front 10 mm. Offering a very secure fit in combination with product pushers. Colours white (01) or black (10).

Shelf length 1000 mm | 49058-xx-K/998  
with adhesive tape

Shelf length 1250 mm | 49058-xx-K/1248  
with adhesive tape

Shelf length 1000 mm | 49058-xx-M/998  
with magnetic tape

Shelf length 1250 mm | 49058-xx-M/1248  
with magnetic tape

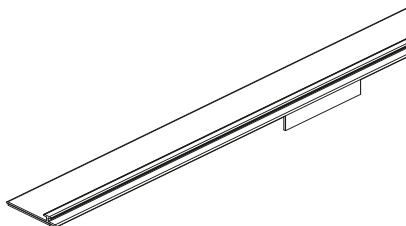

### PRAB-10-M WITH CUTOUTS

T-profile rail with downward front 10 mm and cutouts. To be used in freezers from Assmann, Arneg and Hauser. Colours white (01) or black (10).

Shelf length 1250 mm | 49057-01-M/1243  
white

Shelf length 1250 mm | 49057-10-M/1243  
black



## T-PROFILE RAILS WITH SCANNER PROFILE

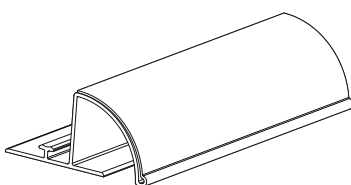

### PRAU-30-SC

T-profile rail (height 20 mm) with adhesive tape 25 mm. With integrated, bent scanner profile for labels 30 mm, transparent. Upon request also available in other colours or with magnetic tape.

Shelf length 1000 mm | 49073-00-K/0998

Shelf length 1250 mm | 49073-00-K/1248

## T-PROFILE RAILS

### T-PROFILE RAILS WITH SCANNER PROFILE

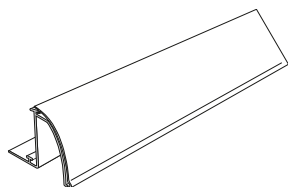

#### PRAU-40-SC

T-profile rail (height 40 mm) with adhesive tape 12 mm. With integrated, bent scanner profile 40 mm, transparent.

Upon request also available in other colours.

Shelf length 1000 mm | 49075-00-K/0998

Shelf length 1250 mm | 49075-00-K/1248

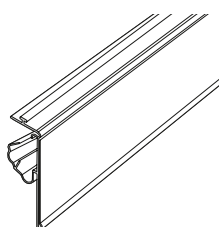

#### PRLST-40

T-profile clamp rail with scanner profile 40 mm. Suitable for shelves from e.g.

Tego, Storebest and Linde, grey.

Shelf length 1000 mm | 49070-03/0988

Shelf length 1250 mm | 49070-03/1238

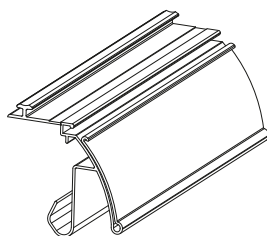

#### K-LINE26

T-profile rail with integrated, bent scanner profile 26 mm, window grey RAL 7040.

Suitable for freezers from Hauser and Carrier.

49590-7040/1247

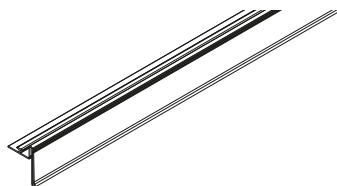

#### PRFL-26-K

T-profile rail with hinge and scanner profile 26 mm, transparent.

PRFL-26-K, 998 mm | 49060-00-K/0998

PRFL-26-K, 1248 mm | 49060-00-K/1248

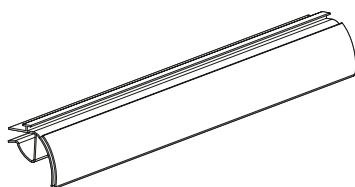
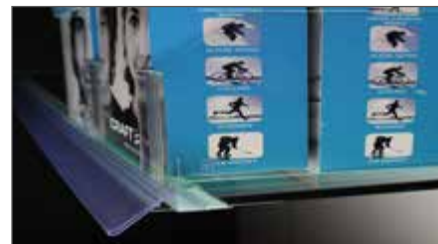

#### PRGL-26

T-profile rail to be clicked onto glass shelves with thickness of 8-10 mm, with integrated, bent scanner profile 26 mm, transparent.

Shelf length 1000 mm | 49085-00/0988

Shelf length 1250 mm | 49085-00/1248

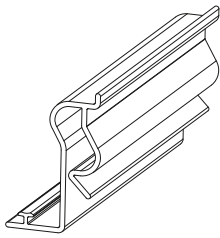

**TK-PROFILE RAIL**

T-profile rail to be fixed on wire shelves. Possibility to assemble a standard TE-scanner rail in front, T-profile rail on the back for fixation of product pushers and shelf dividers, lengths upon request

TK-profile rail | 49088-01/xxx

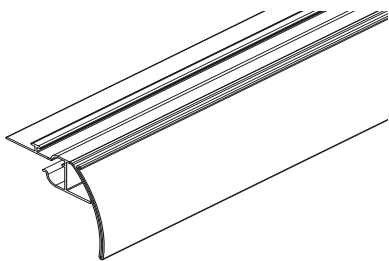

**WIRE-TECH-RAIL**

T-profile rail suitable for WireTech, WireTech 100 and PureTech shelves (Wanzl). With integrated, bent scanner profile 40 mm and hinge, transparent.

Wire-Tech with T-profile | Upon request

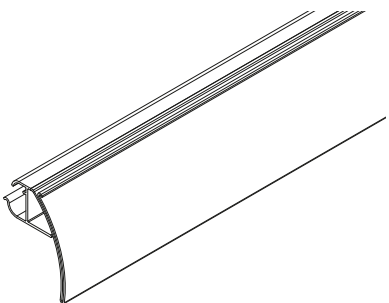

**WIRE-TECH-RAIL**

Scanner rail suitable for WireTech, WireTech 100 and PureTech shelves (Wanzl). With integrated, bent scanner profile 40 mm and hinge, transparent.

Wire-Tech without T-profile | Upon request



## GRAVITY FEED

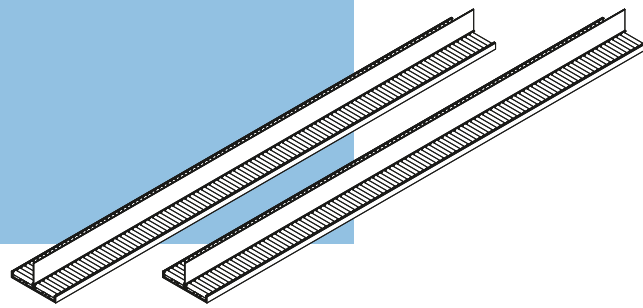

## GRAVITY FEED

The solution for products, that would be difficult or impossible to move with conventional dividers and pushers, due to their shape, size or weight. From these characteristics, however, our systems benefit: Especially bottles, bundles, cans or containers are sliding forward to the shelf front, where they are easy to see and to reach by the customer.



**THE PROBLEM:**  
UNTIDY SHELVES,  
GAPS AND MISSING GOODS



**THE CHANGE:**  
QUICK  
AND EASY

**THE SOLUTION AFTER THE  
CHANGE:**  
CLEAR PRODUCT PLACEMENT,  
FULL SHELVES

### The advantages are convincing:

#### For retailers and brands:

- + easy to adjust when plano-grams change
- + simple to restock for both front and back loading systems
- + increase of sales, as products are visible and available at the shelf front
- + less effort for shelf care – more time for your customers

#### For shoppers:

- + products are always front faced and easy to locate
- + a tidy product presentation helps to increase the shopping experience and time customer spends shopping
- + more staff is available for customer assistance



## GRAVITY FEED

### ROLLER TRACK AND GLIDING TRACK

#### ROLLER TRACK XL

When it comes to heavy products or deep shelves, the roller track XL is the solution. Bundles such as 6-packs of beer or soft drinks, heavy household cleaners or detergent packages - no problem for the roller track XL.

Magnetic pads are holding the tracks securely on the shelf bottom, where they easily can be adjusted in their position, when product layout is changed. Standard length: 485 mm, further lengths upon request.

#### ROLLER TRACK XL

485 x 51,8 mm: centre		6-16148-0059
485 x 51,8 mm: left		6-16148-0060
485 x 51,8 mm: right		6-16148-0061



#### ROLLER TRACK STANDARD

The roller track system for a full installation on inclined or straight shelves. If used with straight shelves the inclination of approx. 7 degrees can be achieved by using a bottom support.

Transparent plastic dividers are positioned into the slots of the front- and end pieces. Through a threefold arrangement with gaps of 12 mm in between no space for products gets lost.

Roller tracks in width of 67 mm and with lengths of 335 to 635 mm every 25 mm. Accessories such as shelf dividers made from plastic or wire, plastic bottom support and front rail made from anodised aluminium to hold transparent front plates, complete the whole system.

#### ROLLER TRACK STANDARD

Roller track 67/335		45650-03/335
Roller track 67/385		45650-03/385
Roller track 67/435		45650-03/435
Roller track 67/485		45650-03/485
Roller track 67/535		45650-03/535
Roller track 67/585		45650-03/585
Roller track 67/635		45650-03/635



#### WIRE DIVIDERS

Height 40 mm, galvanised zinc, diameter 5 mm. For roller track available in lengths: 275 mm, 325 mm, 375 mm, 425 mm, 474 mm, 524 mm and 574 mm.

Wire dividers		46680-00/XXXX/5
---------------	--	-----------------





**PLASTIC DIVIDERS FOR ROLLER TRACK**

Height 30 mm, available in lengths  
287 mm, 337 mm, 387 mm, 437 mm,  
487 mm, 537 mm and 587 mm.

Plastic divider | 46650-82/XXX



**CONNECTOR ROLLER TRACK**

For shelf depths over 635 mm to connect  
the roller tracks, 2x per connection,  
Colour: grey.

Connector roller track | 45655-03



**INCLINED BOTTOM SUPPORT  
ROLLER TRACK**

Breakable from 335 - 635 mm, Colour: grey

Bottom support | 45660-03  
roller track

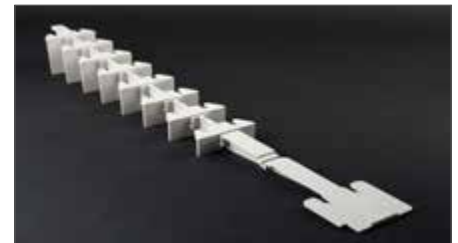

**CLIP FOR FIXATION OF INCLINED  
BOTTOM SUPPORT**

Colour: grey, (4x per track)

Clips | 45661-03



**ALU FRONT RAIL FOR ROLLER TRACK**

For fixation of 5 mm acrylic fronts, Colour:  
anodised aluminium

Alu front rail for | 90-102100/0998  
roller track



## GRAVITY FEED

### ROLLER TRACK AND GLIDING TRACK

#### FRONT RAIL FOR TEGO GROOVE

For shelves with front groove, (support for roller- and gliding track system, when used with inclined shelves), length: 989 mm

49561-00/0989



#### ACRYLIC FRONT

To be used with alu front rails for gliding- and roller track (available upon request)

Size: 998 x 80 x 5 mm | 48630-00/0998/05

Size: 998 x 100 x 5 mm | 48632-00/0998/05

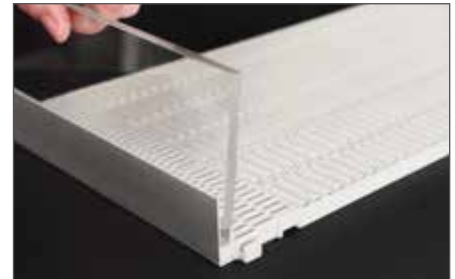

#### GLIDING TRACK

Gliding instead of rolling, the especially slippery surface of our gliding tracks makes heavy products to glide magically easy to the shelf front. The easy to clean, closed surface scores especially when used with food. Low noise and with little inclination even PET-bottles „with star bottom“ are gliding to the front. Cutted into the requested length and equipped with end pieces for a direct fixation onto T-profile rails in the shelf, the gliding track satisfies every customers wish. Dividers made of galvanised wire complete the system. Width of gliding tracks 67 mm.



#### GLIDING TRACK

Available in grey or black. Available lengths 350 mm, 400 mm, 450 mm, 500 mm, 550 mm, 600 mm and 650 mm (incl. front- and end piece ). Special lengths upon request.

Gliding track grey | 45690-03/XXX

Gliding track black | 45690-10/XXX



#### WIRE DIVIDERS

Height 40 mm, galvanised zinc, diameter 5 mm. For gliding track available in lengths: 314 mm, 364 mm, 414 mm, 464 mm, 514 mm, 564 mm and 614 mm.

Wire dividers | 46680-00/XXXX/5



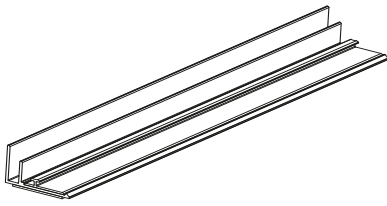

**ALU FRONT RAIL FOR GLIDING TRACK**  
For fixation of 5 mm acrylic fronts,  
with PRT-20 rail, to be used with heavy  
products, colour: anodised

- Shelf length 1000 mm, | 45710-91-K/0998  
adhesive tape
- Shelf length 1000 mm, | 45710-91-M/0998  
magnetic tape
- Shelf length 1250 mm, | 45710-91-K/1248  
adhesive tape
- Shelf length 1250 mm, | 45710-91-M/1248  
magnetic tape

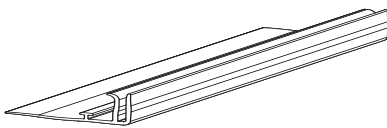
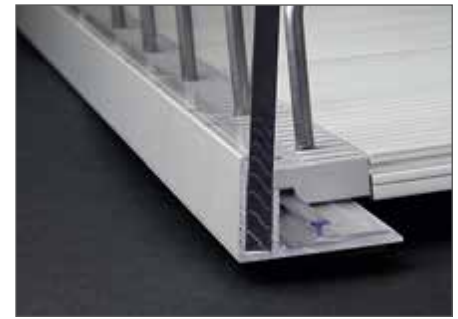

**PRT-40-K**  
T-profile rail with adhesive tape 38 mm  
and adaptor to take a 3 mm thick acrylic  
front, transparent. Acrylic fronts in suitable  
lengths and heights can be produced  
upon request.

- Shelf length 1000 mm | 49089-00-K/0998
- Shelf length 1250 mm | 49089-00-K/1248



**FRONT RAIL FOR TEGO GROOVE**  
For shelves with front groove, (support for  
roller- and gliding track system, when used  
with inclined shelves), length: 989 mm

49561-00/0989



**ACRYLIC FRONT**  
To be used with alu front rails for gliding-  
and roller track (available upon request)

- Size: 998 x 80 x 5 mm | 48630-00/0998/05
- Size: 998 x 100 x 5 mm | 48632-00/0998/05



# SPECIAL APPLICATIONS

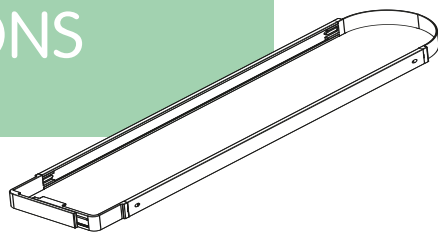

## REFRIGERATION

The new pusher modules made from polystyrene in different widths are offering the advantages of established shelf management systems for your refrigerator too. Made to be used at minus temperatures the modules are accurately fixed on T-profile rails. Whether ice cream in boxes, vegetables in cartons or products in bags, adding an adjustable back support, the goods are always at shelf front and in view of customer. For small products like herbs we offer U-modules made from PET-G. The modules can be combined as desired and are mounted with minimum effort.

### L-BENDED PART SIZE S

With product pusher 2x 10N and 2x rear enlargement 50 x 130 mm.  
Width/height/length: 130 x 120 x 520 mm

L-bended part size S | 47000-00/S/10N

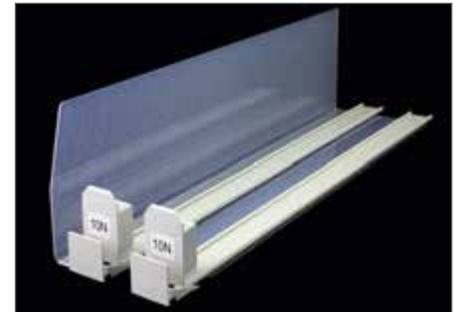

### L-BENDED PART SIZE M

With product pusher 2x 10N and 2x rear enlargement 50 x 130 mm.  
Width/height/length: 190 x 120 x 520 mm

L-bended part size M | 47000-00/M/10N



### L-BENDED PART SIZE L

With product pusher 2x 14N and 2x rear enlargement 50 x 130 mm.  
Width/height/length: 260 x 120 x 520 mm

L-bended part size L | 47000-00/L/14N

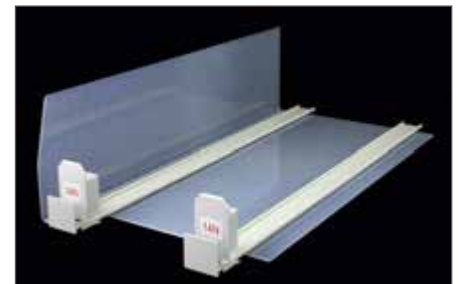

### TK-DIVIDER END PIECE

For wire shelves, diameter 3 mm, height 120 mm, length 520 mm

TK-divider end piece | 47000-00



## SPECIAL APPLICATIONS

### REFRIGERATION

U-TRAY 500 X 77 X 60 MM  
With product pusher 2N.  
Width/height/length: 77 x 60 x 500 mm

U-tray with 2N | 47010-00/02N



U-TRAY 500 X 110 X 40 MM  
With product pusher 4N. Width/height/  
length: 110 x 40 x 500 mm

U-tray with 4N | 47020-00/04N



REAR ENLARGEMENT 50 X 130 MM,  
INCLINED/VERTICAL  
Rear enlargement for pusher housing  
B40. To be used in either inclined or  
vertical position. Colour: grey.

48563-03

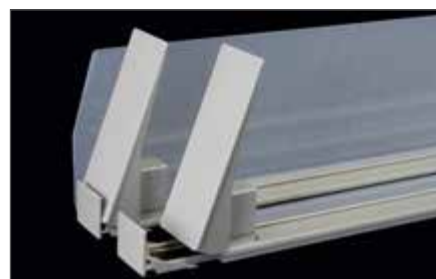
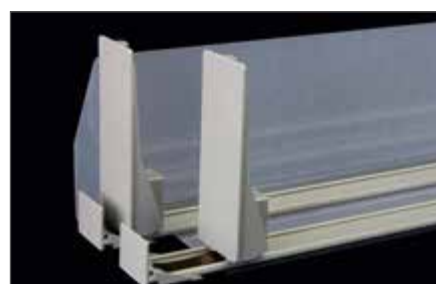

TK-PROFILE RAIL  
TK-profile rail to be fixed on wire shelves.  
Possibility to assemble a standard TE-  
scanner rail in front, T-profile rail on the  
back for fixation of product pushers and  
shelf dividers, lengths upon request

TK-profile rail | 49088-01/xxx



### SRP – SHELF-READY PACKAGING

Supports the presentation of products directly in the covering box supplied by industry. Without unpacking or repacking, from warehouse to shelf - ready to use with little effort. Simply fix the pusher on the rear side of the shelf with a T-profile rail. Then lift up the pusher at the front piece and slide it into the packing tray through the cutout at the rear and beneath the goods. Another T-profile rail ensures a secure hold of the tray in front. Ideal for spices, dry soups, sauces and other products which - by PRIMA SRP - are always presented in an upright position and in view of customer.



#### PRV-PUSHER SRP

Shelf-Ready-Packaging (SRP). Available in 2N, 4N or 6N and in lengths of 275 mm, 320 mm, 340 mm, 375 mm, 420 mm, 440 mm, 475 mm

SRP 2N | 47880-00/XXX/02N

SRP 4N | 47880-00/XXX/04N

SRP 6N | 47880-00/XXX/06N

Special lengths upon request

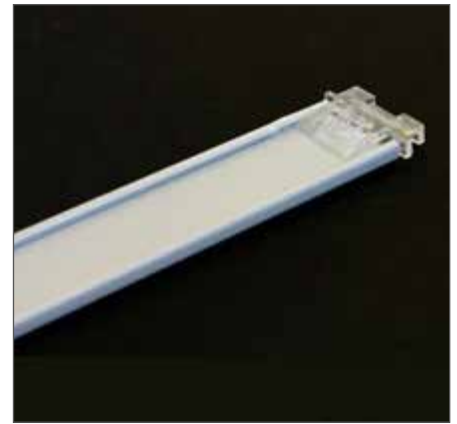

## SPECIAL APPLICATIONS

### PRIMA PTF

#### PRIMA PTF – PULL-TO-FRONT

A simple tool to site products - especially bottles but also other products with a stable bottom - at shelf front. The needed product width (75 - 105 mm) can be adjusted on the plastic front piece, the flexible end piece is adjusting itself automatically. Simply lifting up the PTF over the front rail, the products can be pulled forward. A rail with upward front prevents an unauthorised pulling. Also a scanner rail for product and price information can serve this purpose.

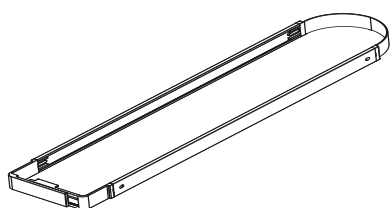

#### PRIMA PTF

For shelf depths 300 to 500 mm. Front- and end piece made from plastics light grey, lengths as alu-C profile anodised.

Length 270 mm | 41100-03/270

Length 320 mm | 41100-03/320

Length 370 mm | 41100-03/370

Length 420 mm | 41100-03/420

Length 470 mm | 41100-03/470

Other lengths and colours of plastic parts available upon request.





## PRIMA 2.0



# PRIMA 2.0

## OVERVIEW



### OVERVIEW PRIMA 2.0

The new generation of product pushers adapts easily to frequent changes in shelf layout!

The pusher unit is firmly connected with the divider, so especially suitable for health and beauty products. Boxes, cans, bottles or tubes, round or square packings - no problem for PRIMA 2.0. Quickly installed and easy to move, this new system adapts easily to changes of product sizes. The clear front is folding back when products are put onto the shelf, thus facilitating shelf care. In addition this feature allows to reduce the vertical distance between the individual shelves.

#### PRIMA 2.0 as you like: with or without „SLOW FEED“

The product pusher is available with conventional springs with 4N, 6N, 8/4N or 10N force or as „SLOW FEED“, the damped pusher type. „SLOW FEED“ makes products move forward slowly and with adapted force. No „snapping“ or „tipping over“ of heavy and high products after withdrawal of goods. „SLOW FEED“ is also the solution for stacked products. It makes the most of given shelf space and increases the visual presence of products.

For wide products or such products that, due to their shape, need a wider base, small supports can be clicked onto the slide rail, even onto both sides if needed, securing a safe stand.



PRIMA 2.0 - WATCH OUR PRODUCT VIDEO ON [WWW.OECHSLE.DE](http://WWW.OECHSLE.DE)

## PRODUCT PUSHER PR 2.0 AND ACCESSORIES

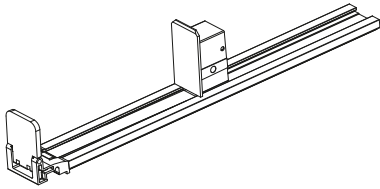

### PRODUCT PUSHER PR 2.0

Product unit consisting of pusher with front anchor and folding front plus sliding rail with special sliding surface in lengths for common shelf depths as follows: length 303 mm (for available shelf depth 335 mm), 328 mm (for 360 mm), 353 mm (for 385 mm), 403 mm for 435 mm), 428 mm (for 460 mm) and 453 mm (for 485 mm).



Special lengths upon request. Colour of pusher housing grey, dimension 30 x 55 mm, height of folding front 40 mm. Slide rail in either grey or black, width 36 mm.

4N		47900-03/xxx/4N
6N		47900-03/xxx/6N
8-4N		47900-03/xxx/8/4N
10N		47900-03/xxx/10N

### PRODUCT PUSHER „SLOW FEED“ WITH DAMPER PR 2.0

As described above plus damper.

47910-03/xxx/10N

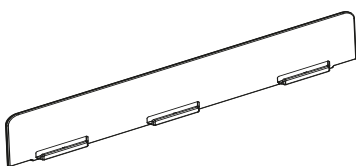

### SHELF DIVIDER PR 2.0

Divider in standard lengths to click onto the slide profile, made of transparent polycarbonate, height 60 mm.

For shelf depth 335 mm		40772-88/307
For shelf depth 360 mm		40772-88/332
For shelf depth 385 mm		40772-88/357
For shelf depth 435 mm		40772-88/407
For shelf depth 460 mm		40772-88/432
For shelf depth 485 mm		40772-88/457

## PRIMA 2.0

### PRODUCT PUSHER PR 2.0 AND ACCESSORIES

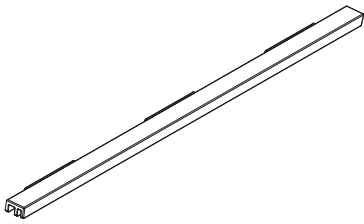

#### SUPPORT PR 2.0

Support to widen the base, clicks onto the slide profile, improving the stability of wide products, made of ABS, colour grey or black, width 12 mm.

For shelf depth 335 mm		45770-xx/307
For shelf depth 360 mm		45770-xx/332
For shelf depth 385 mm		45770-xx/357
For shelf depth 435 mm		45770-xx/407
For shelf depth 460 mm		45770-xx/432
For shelf depth 485 mm		45770-xx/457

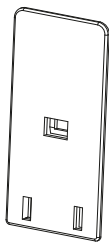
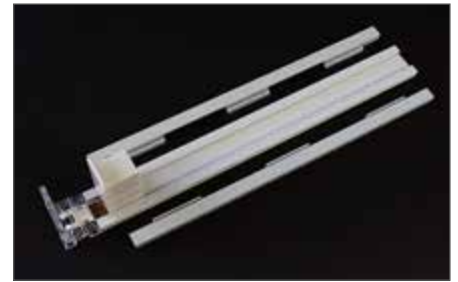

#### REAR ENLARGEMENT PR 2.0

Clicks onto the pusher housing, recommended for wide and high products made of ABS grey, dimensions 51 x 100 mm

48800-03

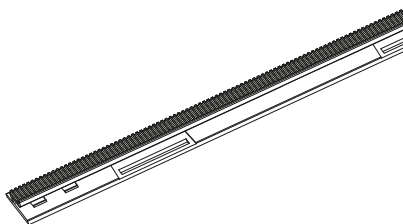

#### FRONT RAIL PR 2.0

Rail to fix the product pusher PR 2.0, made of ABS grey or black with strong magnetic tape or adhesive. Also available with clips to fix onto wire shelves. Dimensions: length 499 mm, width 27,5 mm.

For wire shelves		48400-xx
With adhesive tape		48400-xx/KB
With magnetic tape		48400-xx/MB



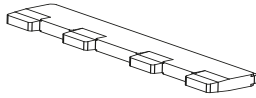

CONNECTOR FOR FRONT RAIL PR 2.0  
Made of ABS grey or black, length 54,7 mm

48405-xx



FIXING CLIPS PR 2.0  
Made of ABS grey or black, for wire diameter 3 mm

48410-xx

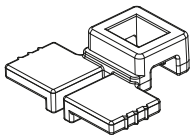

ENDCLIP PR 2.0  
Rear fixing of slide rail PR 2.0, made of ABS grey or black, length 10 mm.

84-48082-03



PRIMA 2.0 with dividers assembled both sides:  
Products in tubes are safely guided!



# SHELF MANAGEMENT SYSTEMS

## INDEX

<b>A</b>		<b>L</b>	
ACRYLIC FRONT _____	50, 51	LABELHOLDER FOR VARIOTRAY B30 _____	37
ALU-FRONT RAIL FOR GLIDING TRACK _____	51	L-BENDED PART FOR REFRIGERATION _____	53
ALU-FRONT RAIL FOR ROLLER TRACK _____	49	<b>M</b>	
<b>B</b>		MAGNETIC BACK SUPPORT _____	33
BACKREST PRRW-A _____	32	MANUAL PUSHER 3-PARTS _____	32
BACKREST PRRW-B _____	33	<b>N</b>	
BACKREST PRRW-C _____	33	NEON _____	21
BOTTOM SUPPORT ROLLER TRACK _____	49	<b>P</b>	
<b>C</b>		PLASTIC DIVIDERS FOR ROLLER TRACK _____	49
CLIPS FOR BOTTOM SUPPORT _____	49	POSTER POCKET 20 X 20 CM WITH 3 HOLES _____	31
CONNECTOR ROLLER TRACK _____	49	PRAB-10 _____	43
<b>E</b>		PRAB-8-K _____	43
END CAP FOR RELING _____	34	PRAU-30 _____	41
END CLIP FOR SLIDING RAIL _____	28	PRAU-30-SC _____	43
<b>F</b>		PRAU-39-K _____	42
FIXING CLIPS _____	40,42	PRAU-40-SC _____	44
FIXING RAIL FOR PRIMA _____	30	PRAU-60-K _____	42
FIXING RAIL FLAT _____	30,37	PRFL-26-K _____	44
FRONT AND BACK SUPPORT FOR DIVIDERS _____	34	PRGL-26 _____	44
FRONT FOR VARIOTRAY _____	37	PRIMA 1 _____	10,18
FRONT RAIL FOR TEGO GROOVE _____	50,51	PRIMA 1+S _____	8,13
FRONT STOPPER FOR DIVIDER STANDARD _____	30	PRIMA 2 _____	10,19
<b>G</b>		PRIMA 2+S _____	8,14,15
GLIDING TRACK _____	50	PRIMA 3+S _____	9,15,16,17
GRAVITY FEED _____	46	PRIMA 4 _____	10,19
<b>K</b>		PRIMA 4+S _____	9,16
K-LINE26 _____	44	PRIMA 5+S _____	9,17



PRIMA 6+T _____	11,20	<b>R</b> _____	
PRIMA 7+C _____	11,20	REFRIGERATION _____	53
PRKL _____	41	RELING _____	34
PRKL-S CLAMP RAIL FOR TEGO _____	41	REAR ENLARGEMENT INCLINED/VERTICAL, GREY _____	29,54
PRLST-40 _____	44	REAR ENLARGEMENT, TRANSPARENT _____	29
PROGRESSIVE SPRING FORCE _____	24	ROLLER TRACK XL AND STANDARD _____	48
PRRW-A _____	32	<b>S</b> _____	
PRRW-B _____	33	SHOPPER STOPPER PRIMA _____	31
PRRW-C _____	33	SLIDING RAIL _____	28
PRT-10-K _____	39	SLIDING RAIL FOR MANUAL PUSHER _____	32
PRT-13-M _____	39	SLIDING RAIL SYSTEM S _____	28
PRT-20 _____	39	SLOW FEED _____	25
PRT-30 _____	39,4	SQUARE DIVIDER _____	31
PRT-40 _____	40,51	SRP-SHELF-READY PACKAGING _____	55
PRV+S H0 _____	12,22	PRODUCT STOPPER PRST _____	32
PRV+S H15 _____	12,22	<b>T</b> _____	
PRV+S H30 _____	12,23	TK-DIVIDER-END PIECE _____	53
PRV+S H60 _____	12,23	TK-PROFILE RAIL _____	45,54
PRV+S MINI _____	12,24	T-PROFILE RAILS _____	39 - 45
PRV+S SLIM H0 _____	12,22	<b>U</b> _____	
PRV+S SLIM H30 _____	12,23	U-TRAY FOR REFRIGERATOR _____	54
PRV+S SLOW-FEED H30 _____	12,25	<b>V</b> _____	
PRV H16 _____	12,26	VARIOTRAY _____	36
PRV H35 _____	12,26	VARIOTRAY END PIECE _____	37
PRV SLIM H35 _____	12,26	<b>W</b> _____	
PRV-T H0 _____	13,27	WIRE DIVIDER _____	48, 50
PRV-T H30 _____	13,27		
PTF – PULL-TO-FRONT _____	56		

**YOUR COMPETENT TEAM FOR  
CREATIVE ALLROUND SOLUTIONS**



**werba**

**werba display prints**  
*reliable and innovative*

werba print und display GmbH & Co. KG  
Am Froschbächle 23  
D-77815 Bühl (Baden)  
Phone +49 (0) 72 23 / 98 64-0  
Fax +49 (0) 72 23 / 98 64-30  
[www.werba-print.de](http://www.werba-print.de)

**OEK**

**oechsle display systems**  
*reliable and innovative*

Oechsle Display Systeme GmbH  
Rudolf-Wanzl-Straße 13-15  
D-89340 Leipheim  
Phone +49 (0) 82 21 / 27 98-0  
Fax +49 (0) 82 21 / 27 98-27  
[www.oechsle.de](http://www.oechsle.de)